

#RE
LUX
100%

#RE
HYBRID
90%

#RE
80%

MARCOS TELESCÓPICOS

TELESCOPIC FRAMES

CATÁLOGO
2025





PRODUCT
CATALOG

TELESCOPIC
FRAMES

VERSION 01



CATÁLOGO
PRODUCTO

MARCOS
TELESCÓPICOS

VERSIÓN 01



CATALOGUE
PRODUITS

CADRE
TÉLESCOPIQUE

VERSION 01



KATALOG
PRODUKT

TELESKOPRAHMEN

AUSFÜHRUNG 01







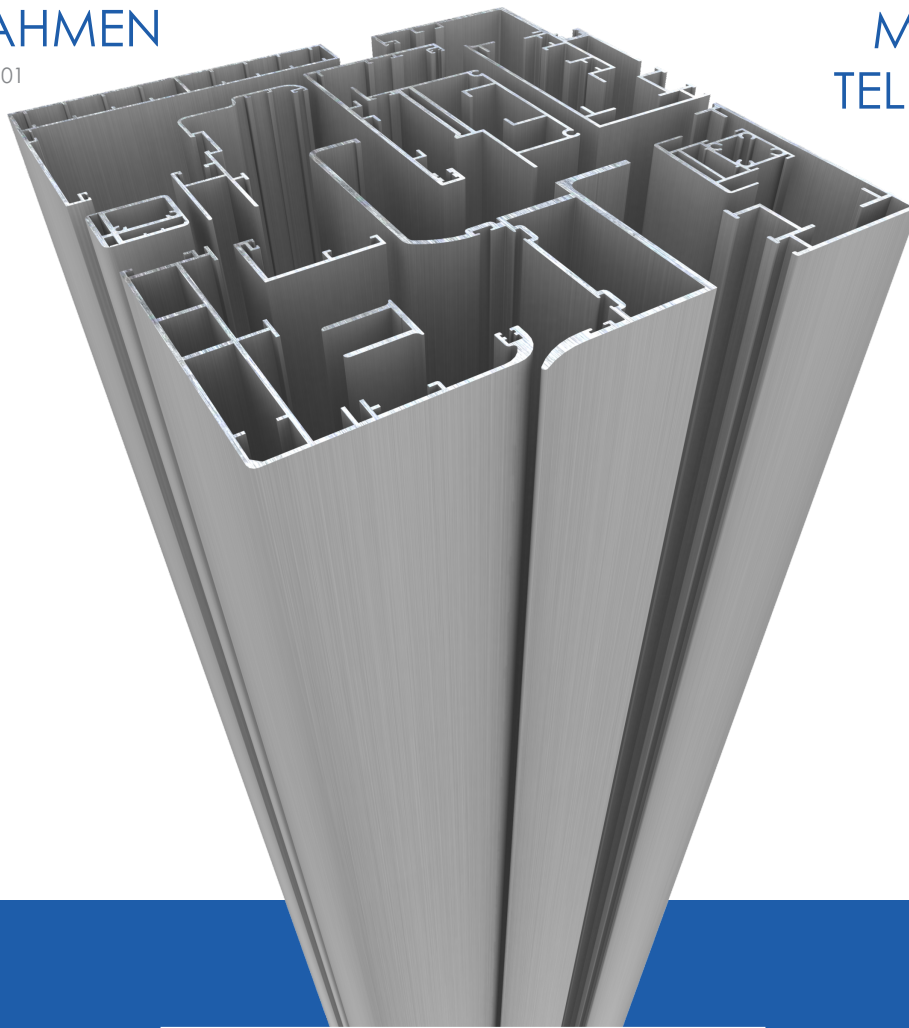

CATÁLOGO
PRODUTOS

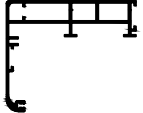
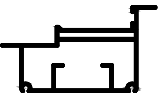



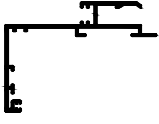
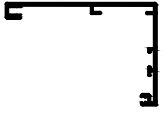
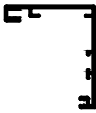
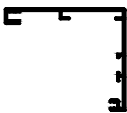

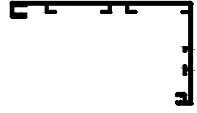
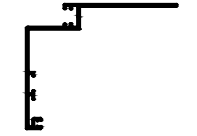
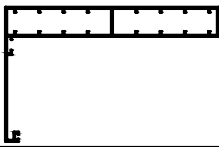
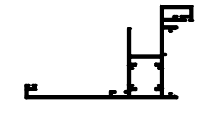
MOLDURA
TELESCÓPICA

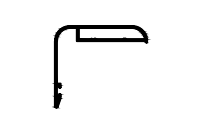
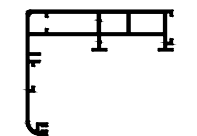
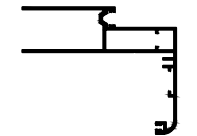
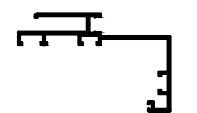
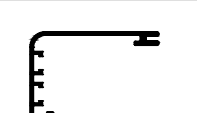

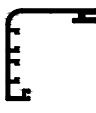
VERSÃO 01

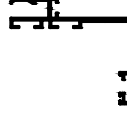

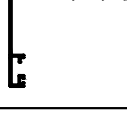
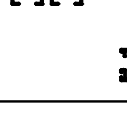
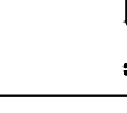
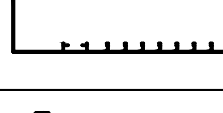
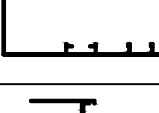
Referencia	Diseño	Descripción	Peso Kg/m	Perímetro mm	
				Total	Exterior
A-01088		marco telescópico	1,957	880	587
A-06093		marco telescópico	1,859	753,9	347,5
A-06866		marco telescópico	1,069	507,2	256,9
A-06867		marco telescópico	0,717	304,3	198,6
A-06965		marco telescópico	0,682	256,6	-
A-07142		soporte marco telescópico	0,353	134,5	-
A-07141		marco telescópico	1,362	561,7	-
A-07155		marco telescópico	1,208	477	-
A-07156		marco telescópico	0,992	397	-
A-07157		marco telescópico	1,100	437	-

Referencia	Diseño	Descripción	Peso Kg/m	Perímetro mm	
				Total	Exterior
A-07158		marco telescópico	1,400	558,2	-
A-08024		marco telescópico	1,185	469,2	-
A-11333		marco telescópico	1,336	653,7	508,4
A-11334		marco telescópico	0,105	80	478,5
CI-001-0286		solape especial 54 mm	0,676	357	260,2
CI-001-0323		solape especial 54 mm	0,661	349,1	252,2
CI-001-0646		marco telescópico	1,919	886,8	594,4
CI-001-0647		marco telescópico	1,724	806,2	669,7
CI-164-0011		marco telescópico interior	1,443	558,8	-
CI-164-0012		marco telescópico interior	1,128	425	-

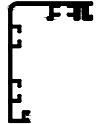
Referencia	Diseño	Descripción	Peso Kg/m	Perímetro mm	
				Total	Exterior
CI-164-1055		marco telescópico interior 60 mm	0,993	375	-
CI-164-1309		marco telescópico	0,912	345	-
CI-164-1078		marco telescópico hembra 62 mm	1,456	503,2	-
CI-1641079		marco telescópico macho 85 mm	1,043	443	-
L-200165		marco telescópico exterior	1,037	441	-
L-200166		marco telescópico interior	1,456	500	-
L-200606		marco telescópico interior	1,005	503	-
L-201180		marco telescópico exterior	1,704	713	-
L-201184		marco telescópico exterior	1,253	530	-
L-300073		forro puerta recto hembra 90 x 29,8 mm	1,974	702	-

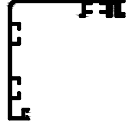
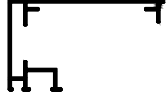
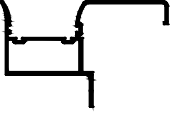
Referencia	Diseño	Descripción	Peso Kg/m	Perímetro mm	
				Total	Exterior
L-300076		forro puerta recto macho 88 x 12,7 mm	1,340	527	-
L-300074		forro puerta recto ajunquillador 43,5 x 27 mm	0,430	193	-
L-300077		forro puerta recto macho 88 x 65 x 12,7 mm	1,456	575	-
I-09588		moldura	1,341	548,7	-
J-02759		marco moldura telescópico interior	3,103	877,9	674,6

A-01088

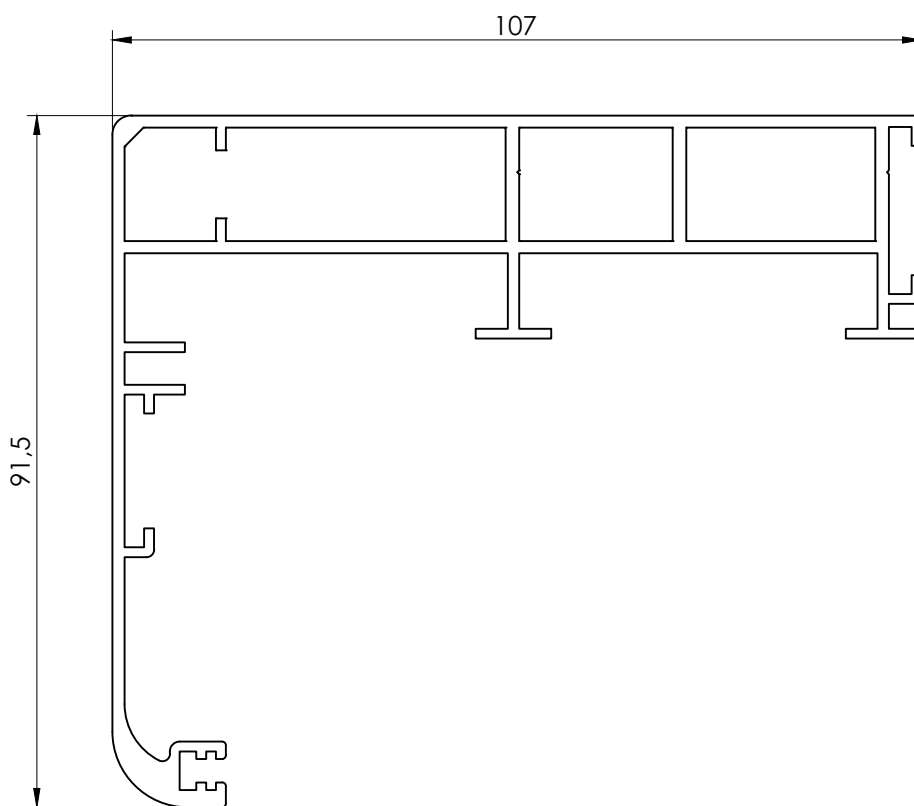

A-06093

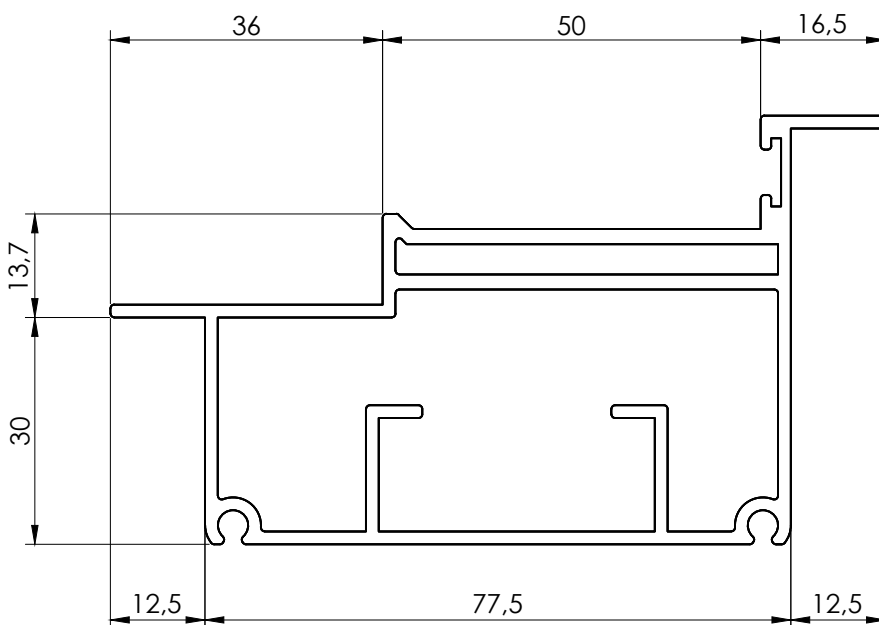

A-06866

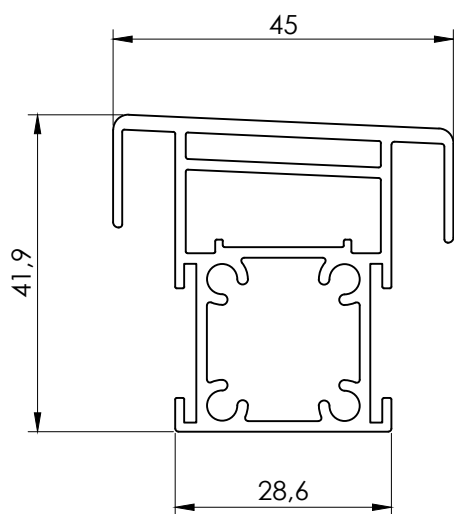

A-06867

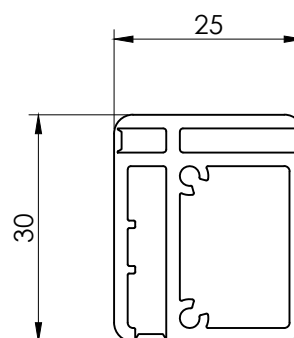

A-06965

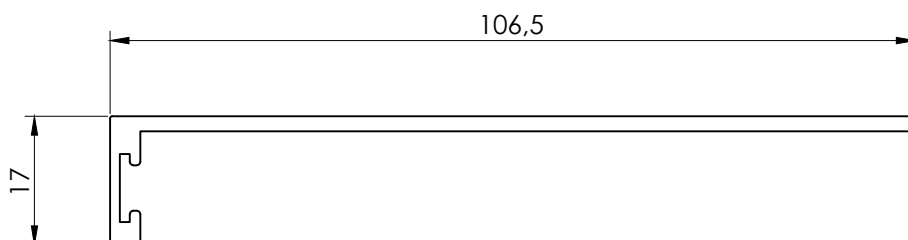

A-07142

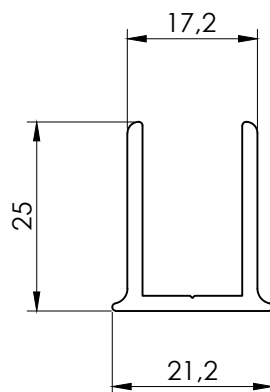

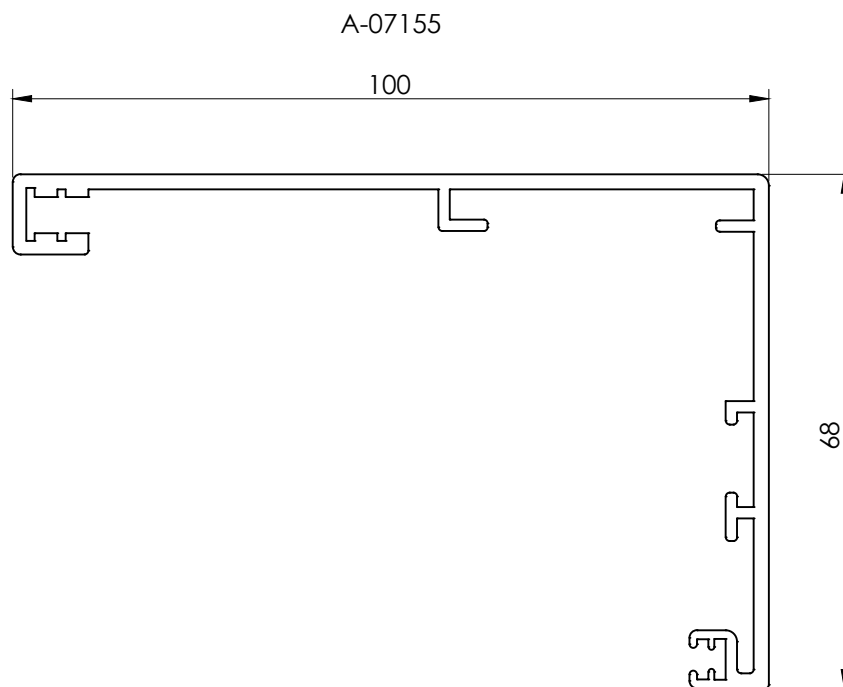
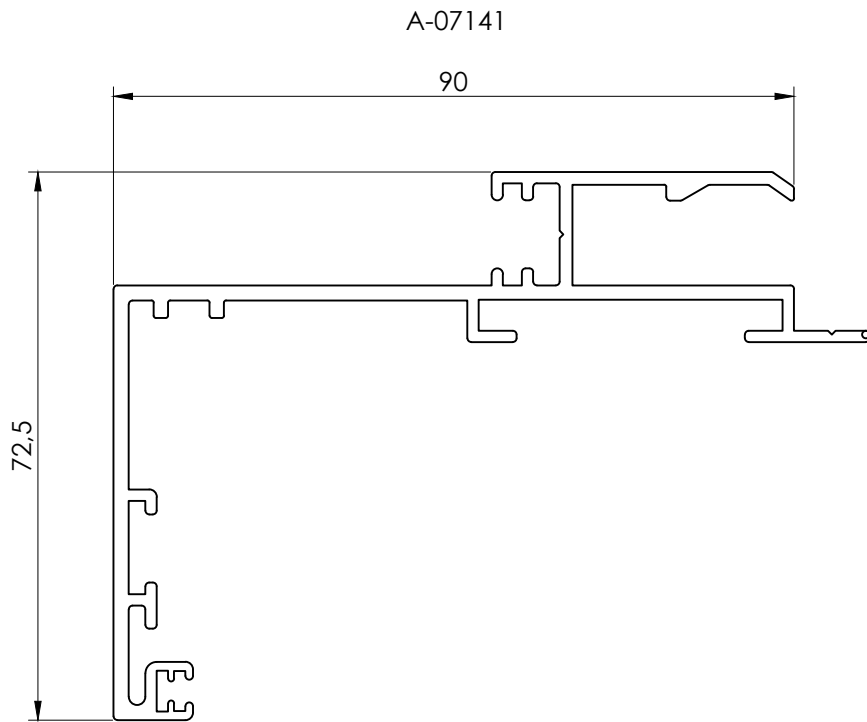

A-07156

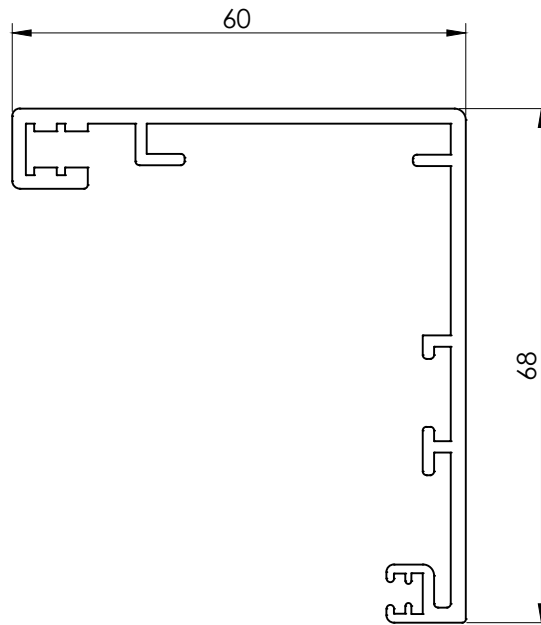

A-07157

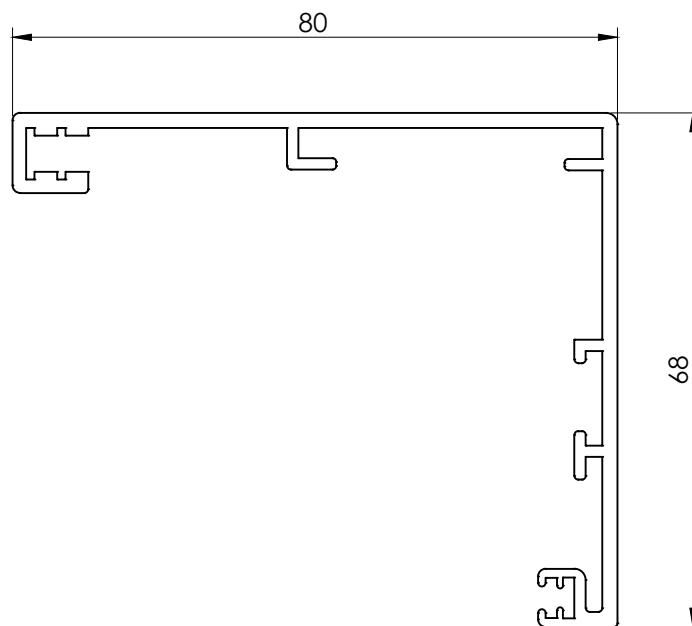

A-07458

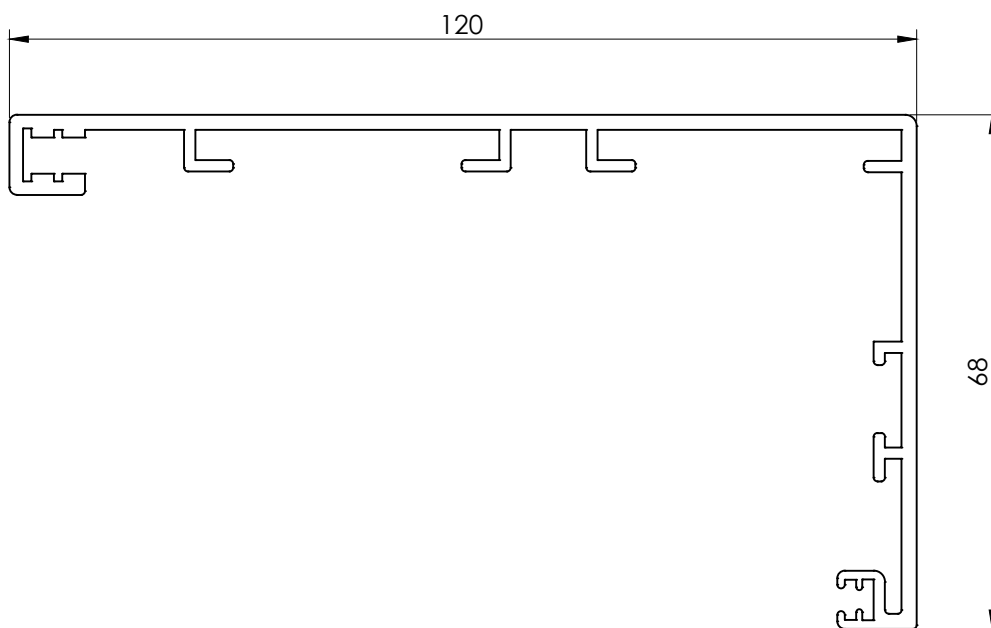

A-08024

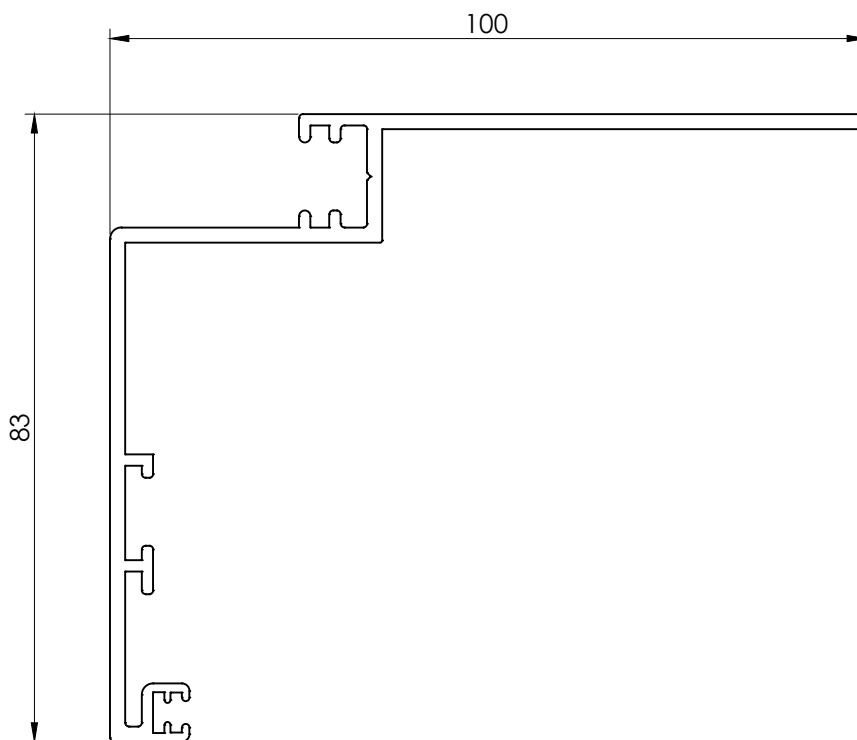

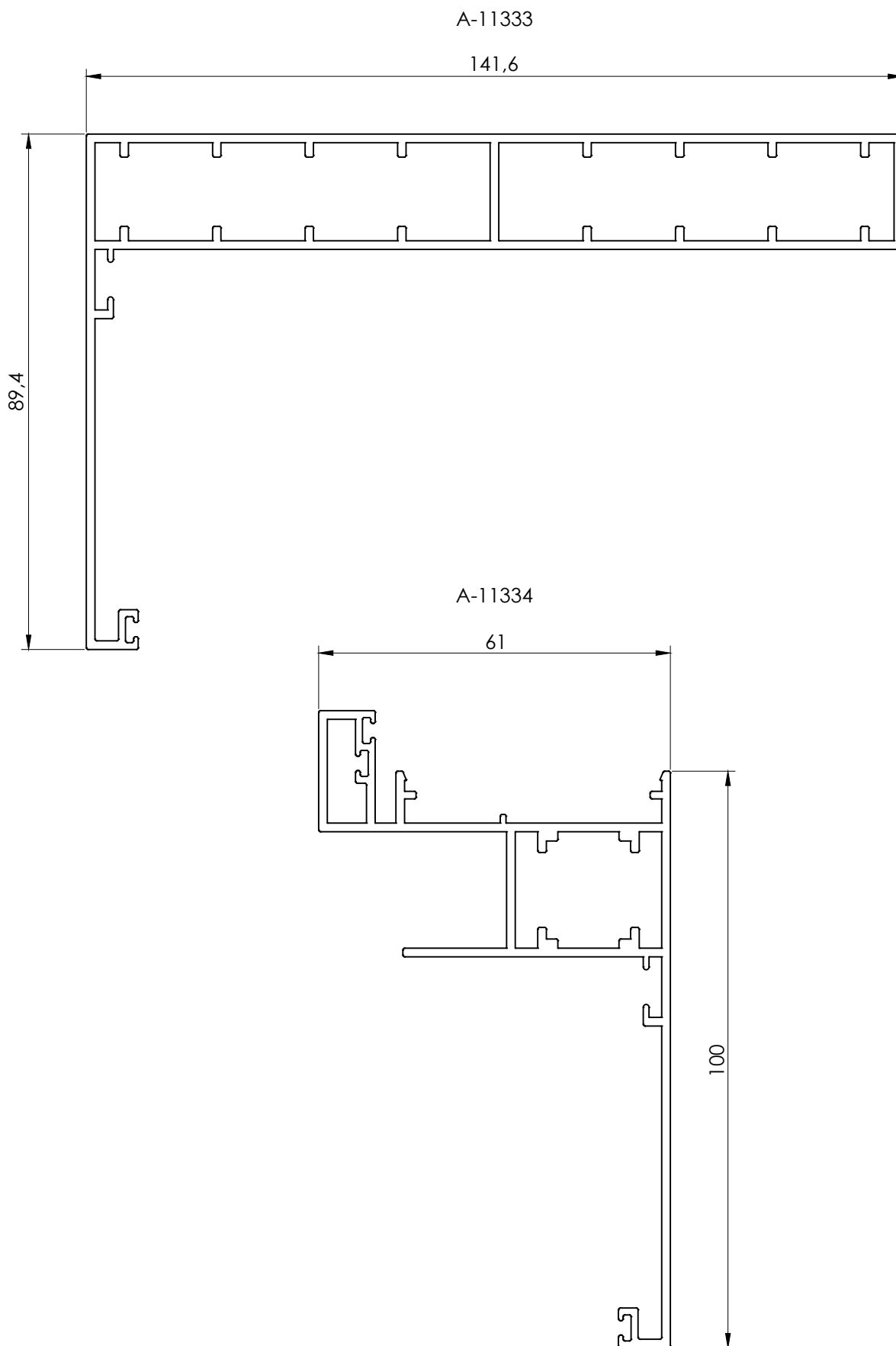

CI-001-0286

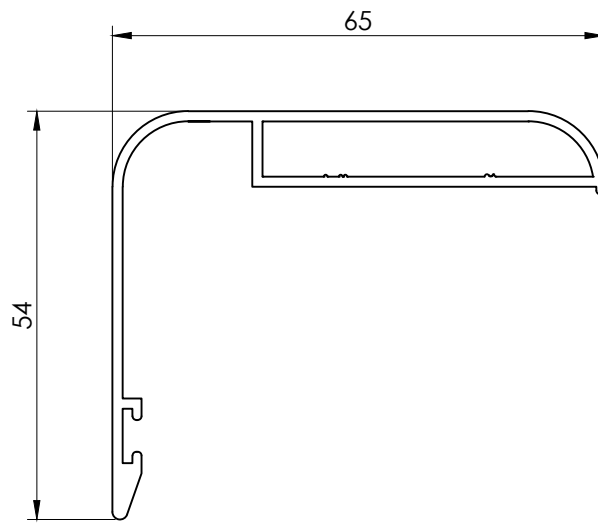

CI-001-0323

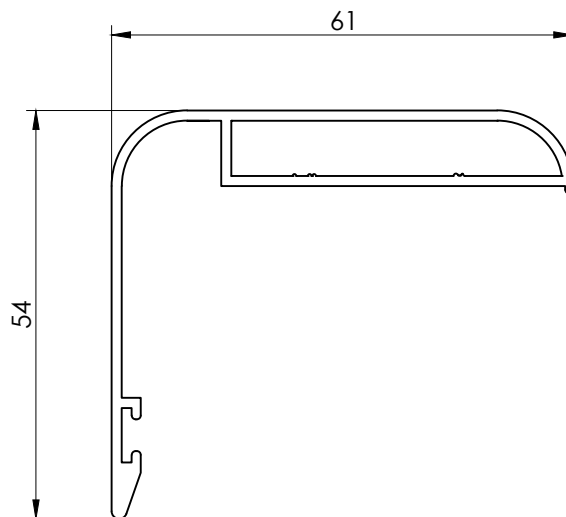

CI-001-0646

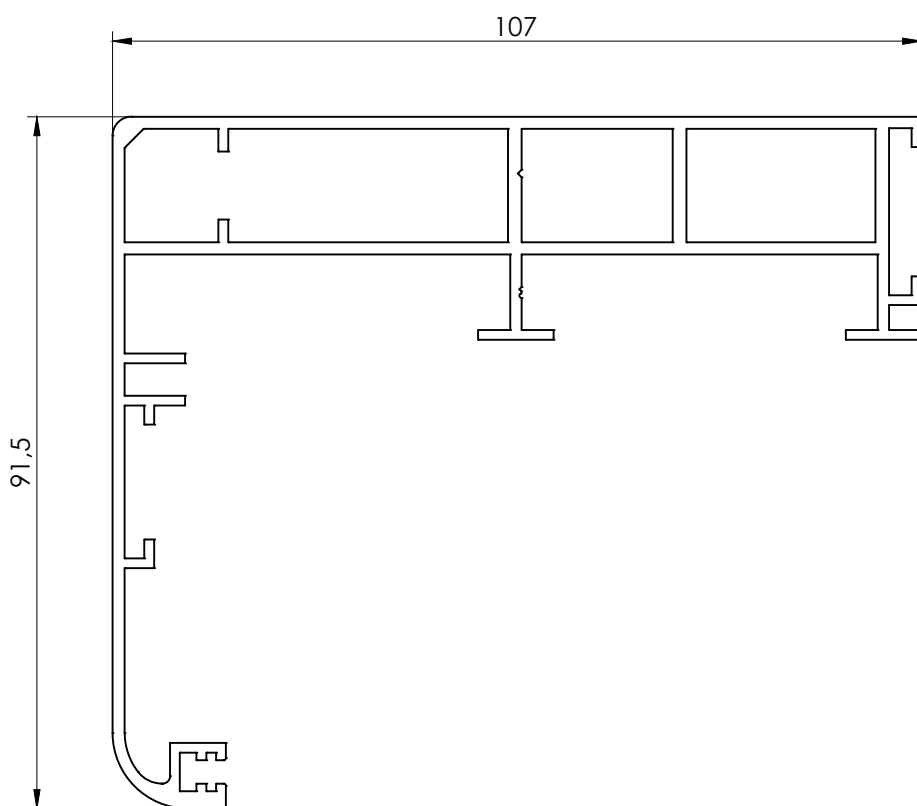

CI-001-0647

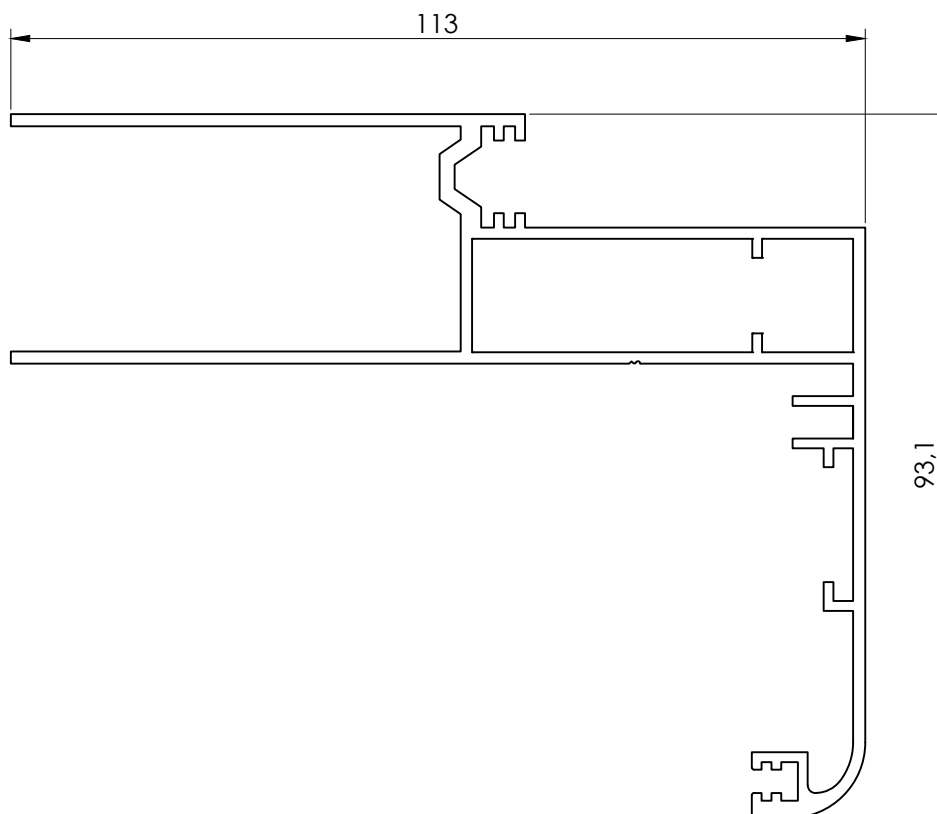

CI-164-0011

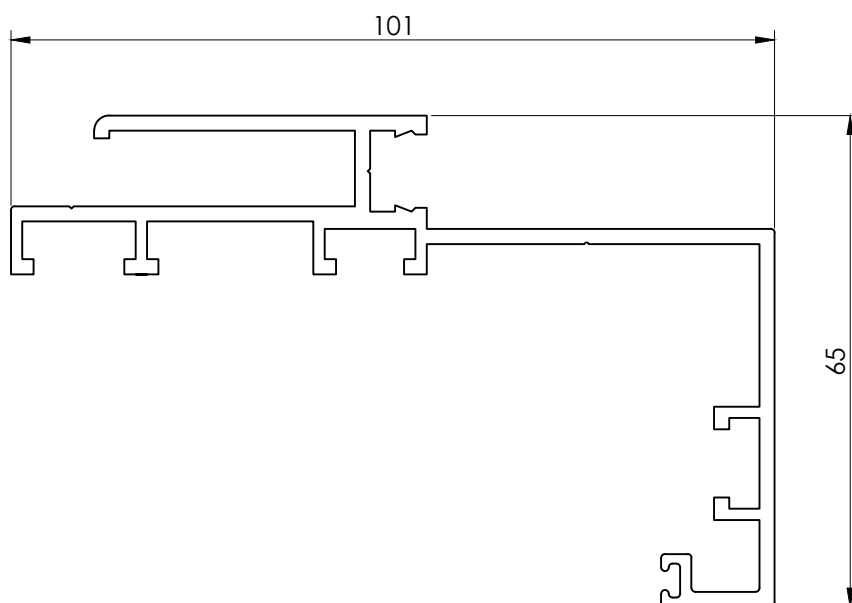

CI-164-0012

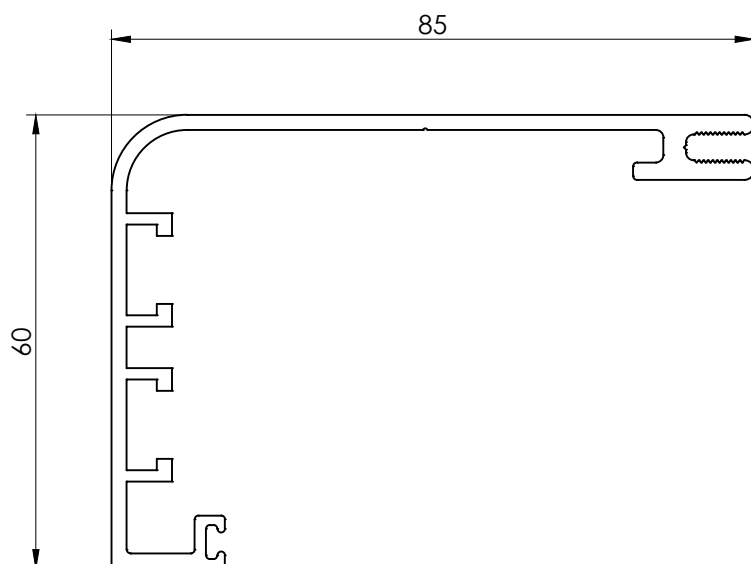

CI-164-1055

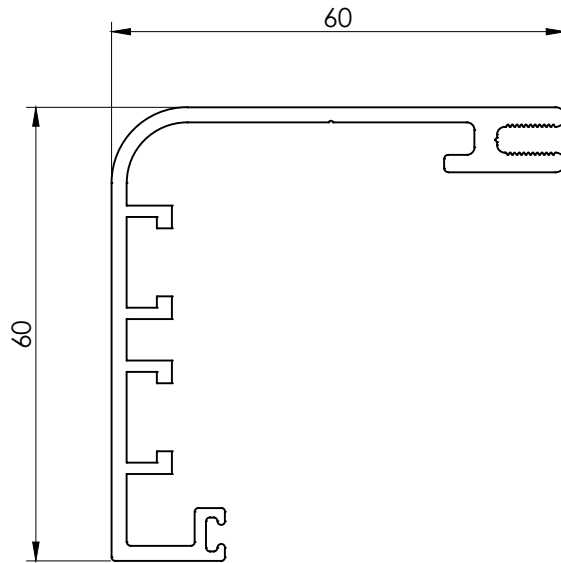

CI-164-1309

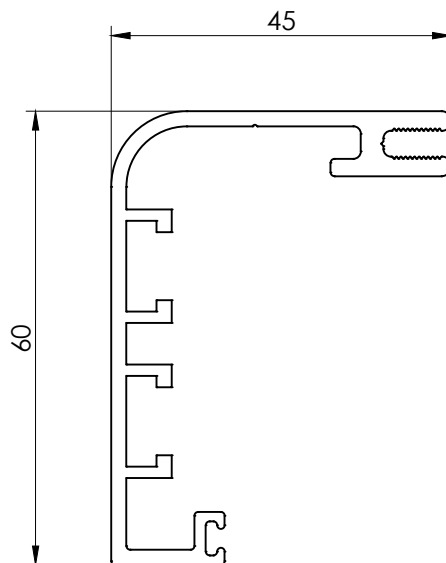

CI-164-1078

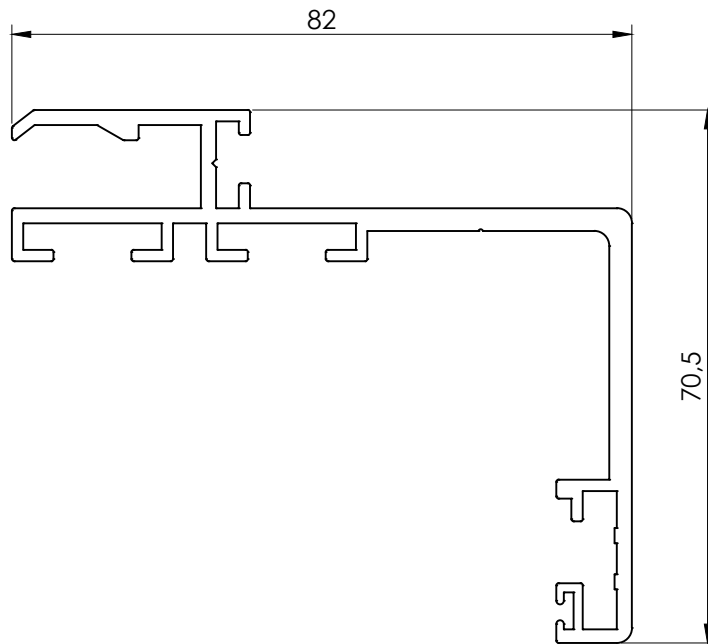

CI-164-1079

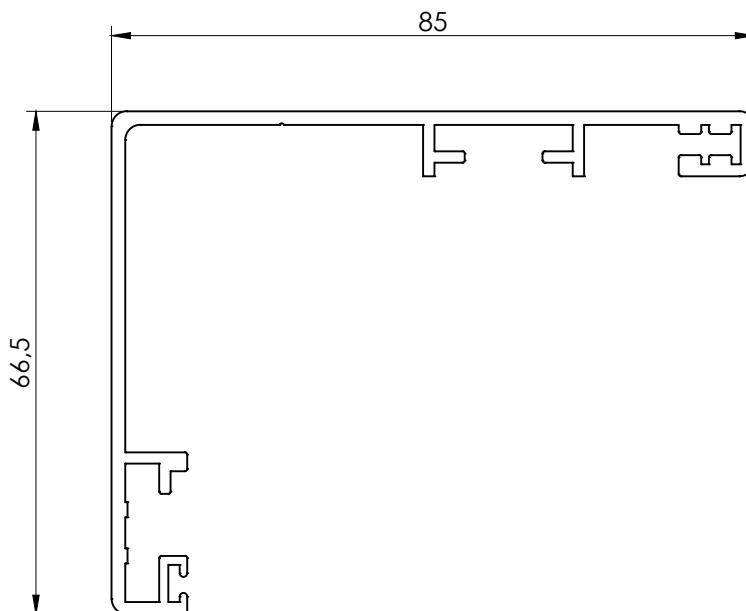

L-200165

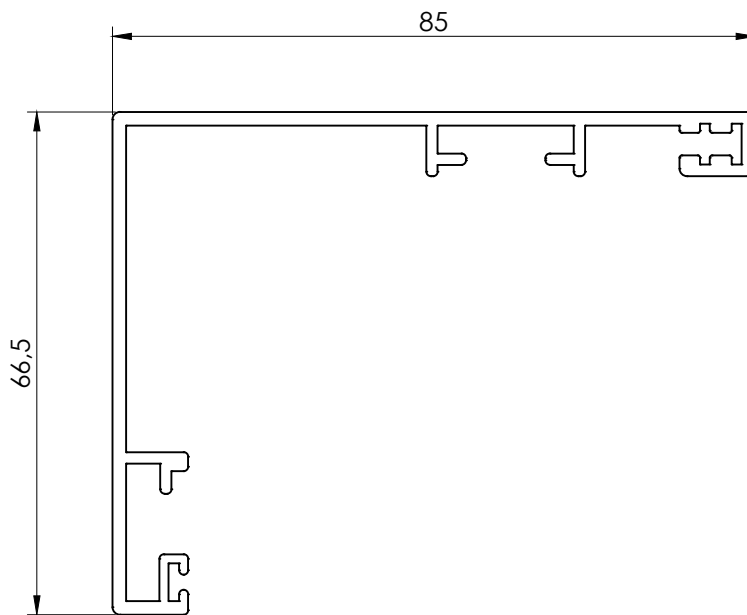

L-200166

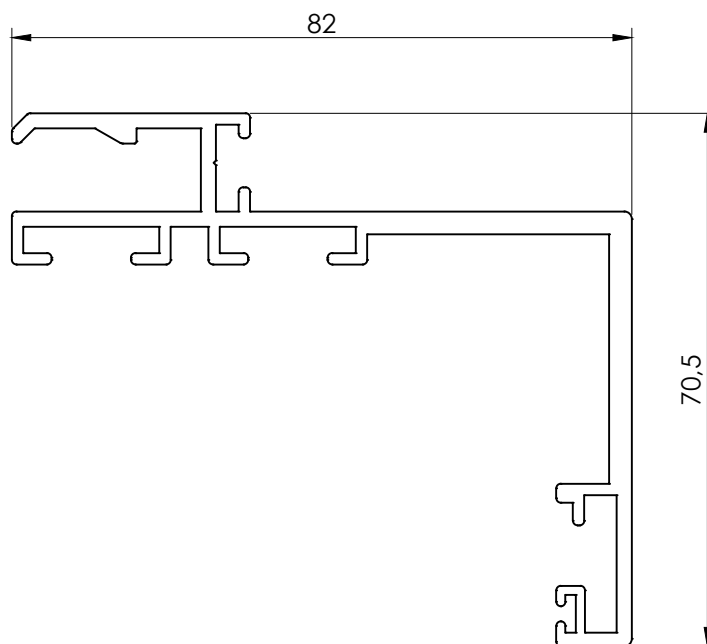

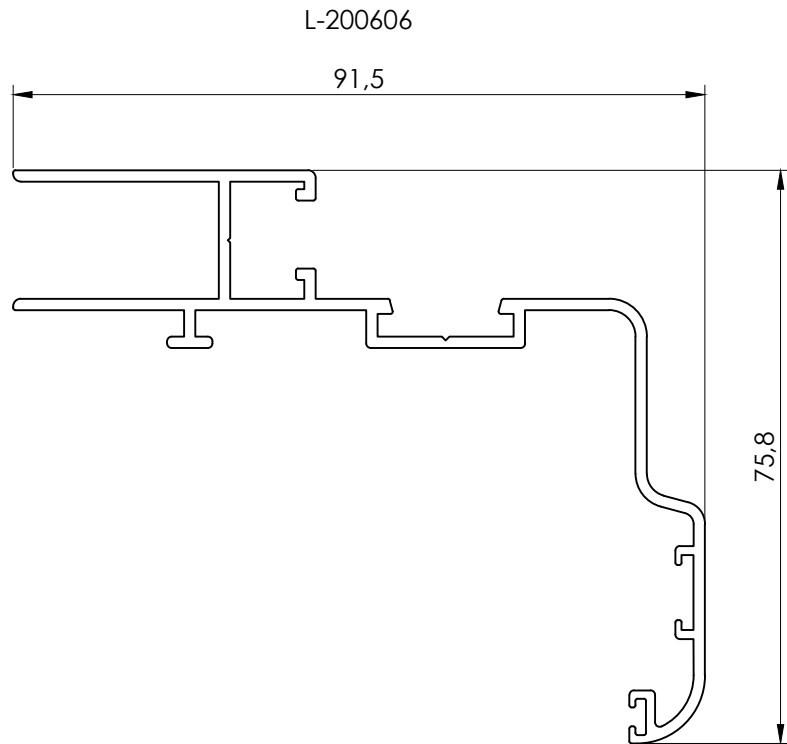

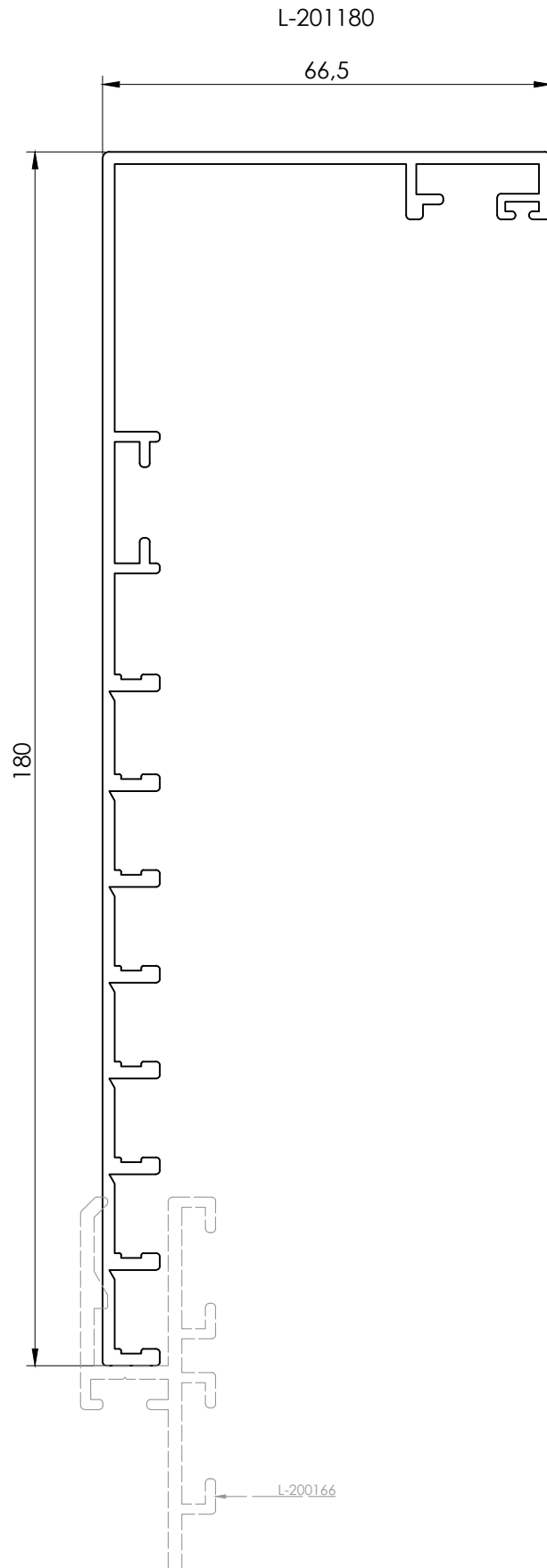

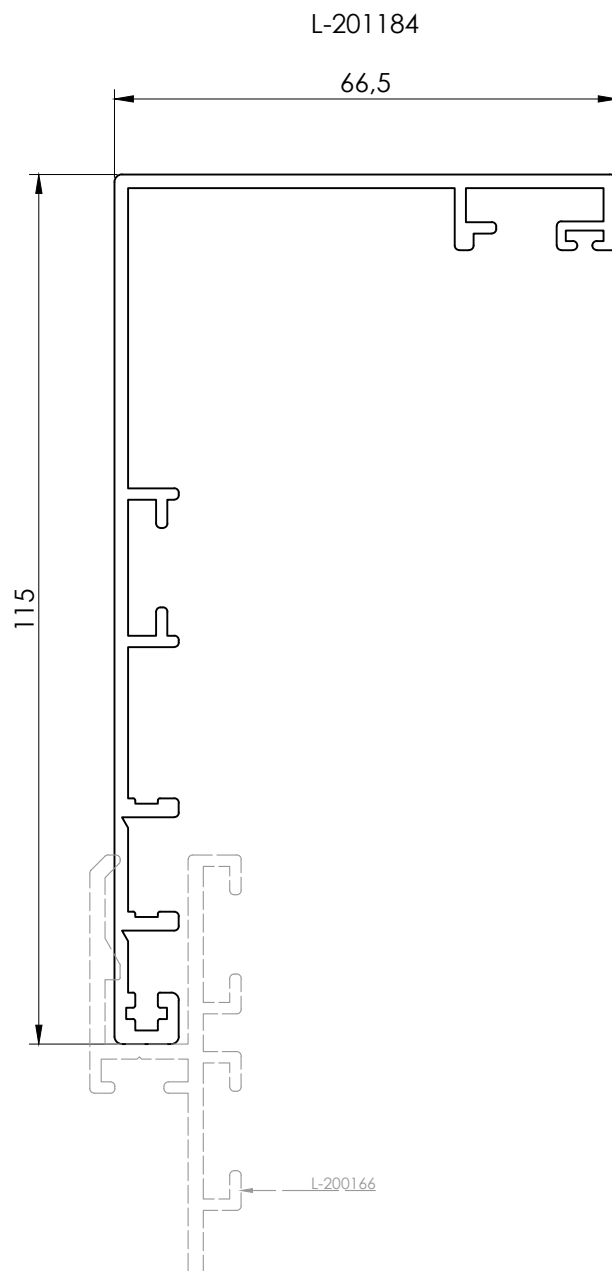

L-300073

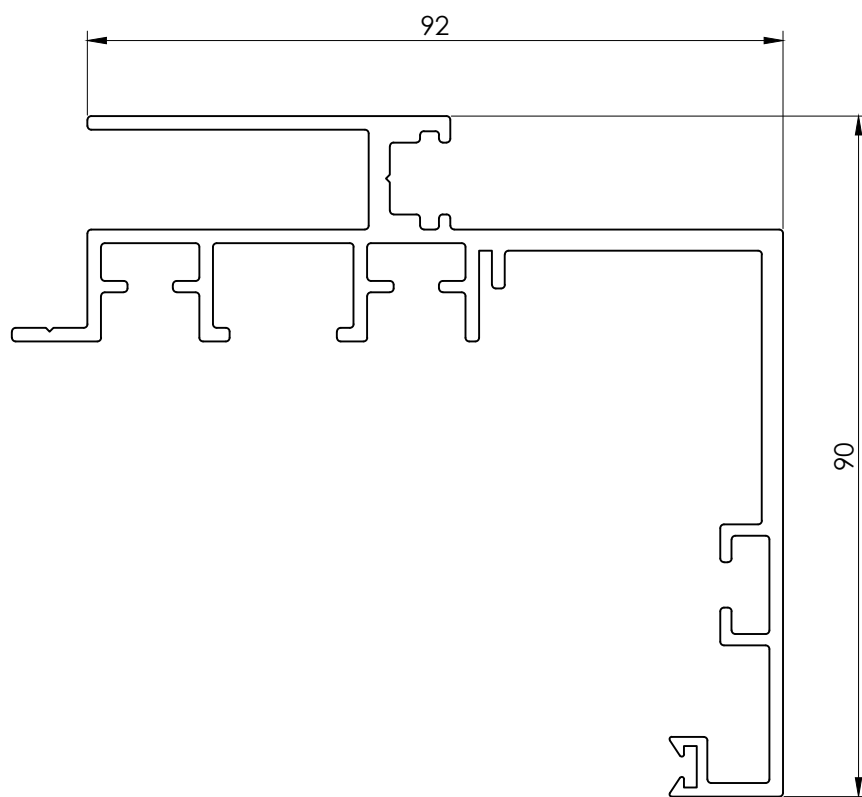

L-300076

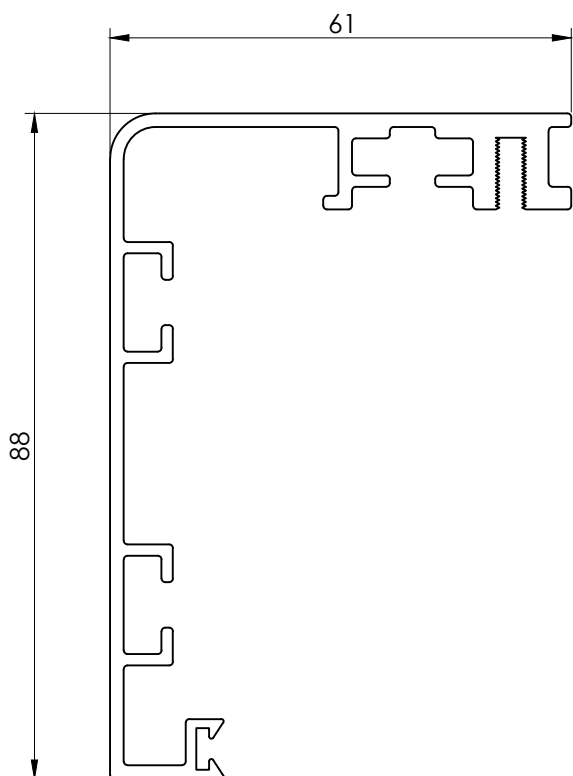

L-300074

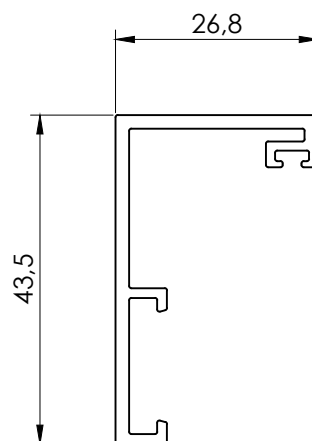

L-300077

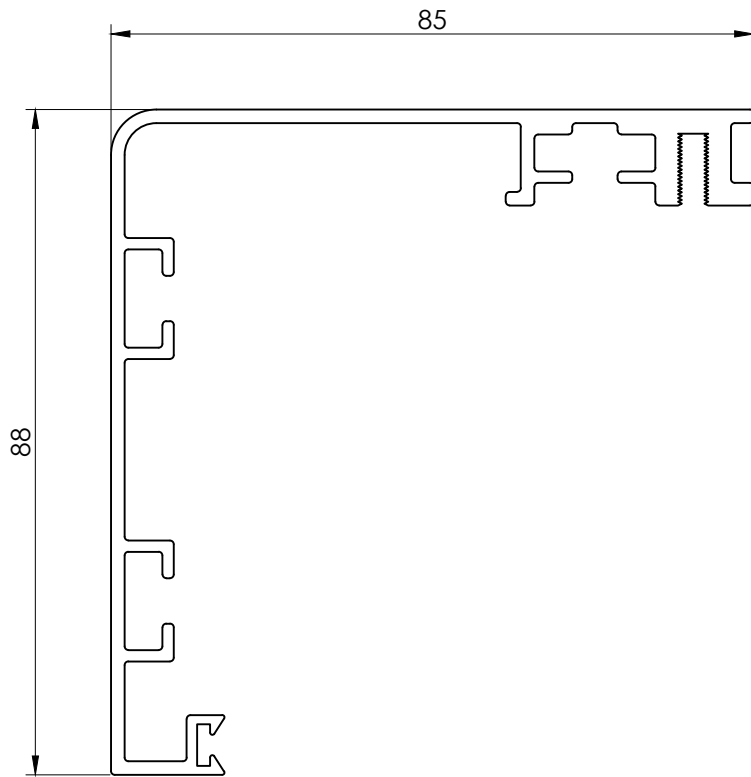

I-09588

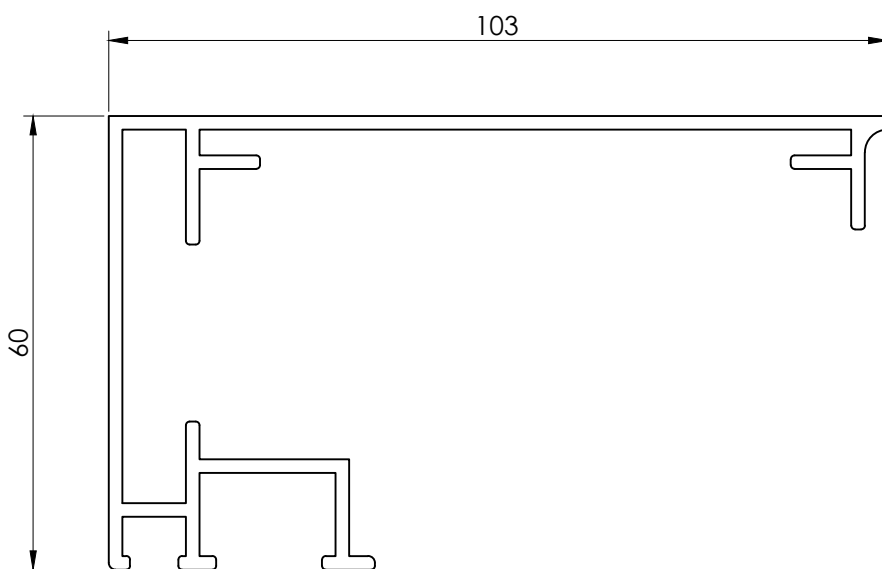

J-02759

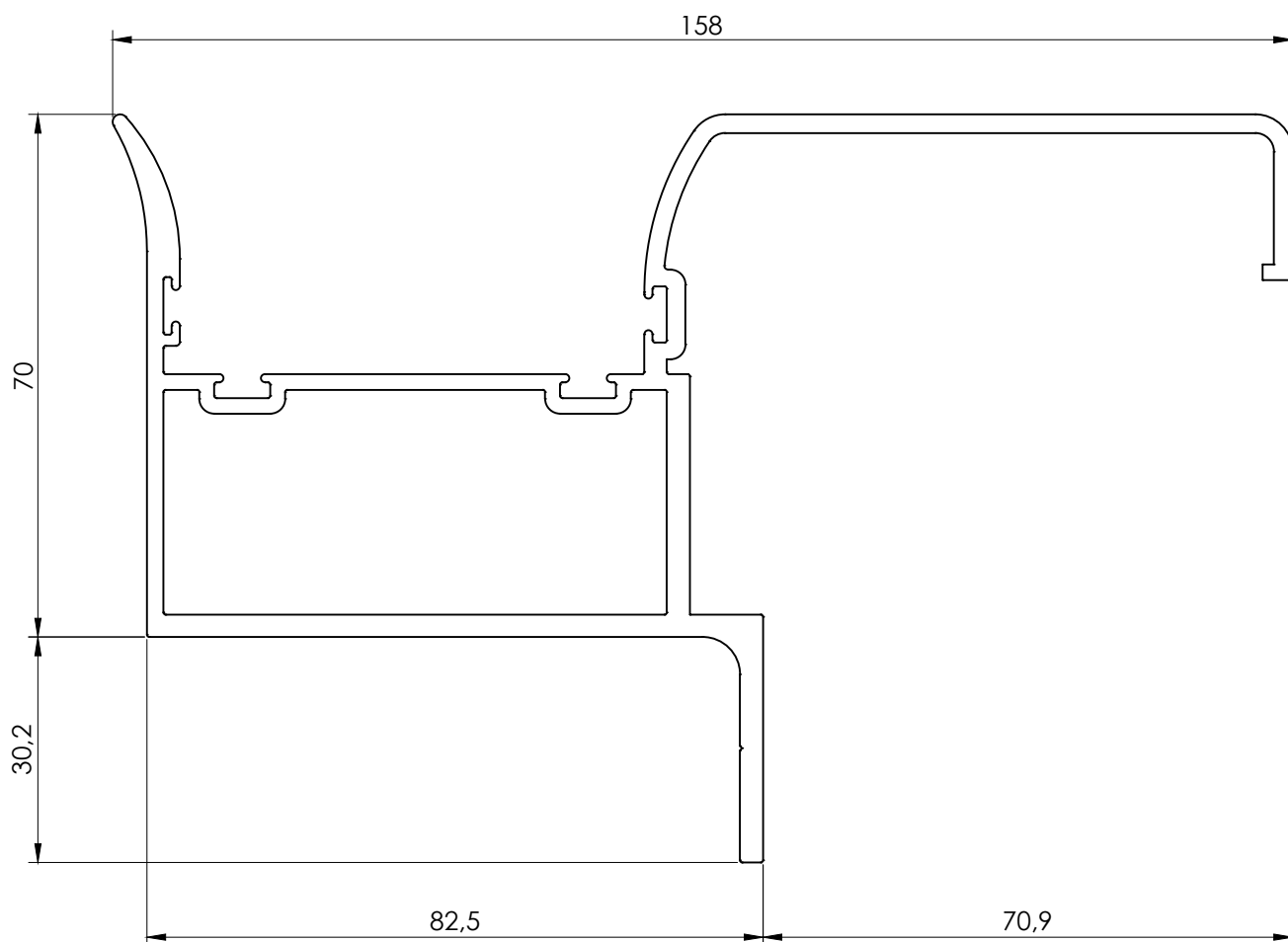

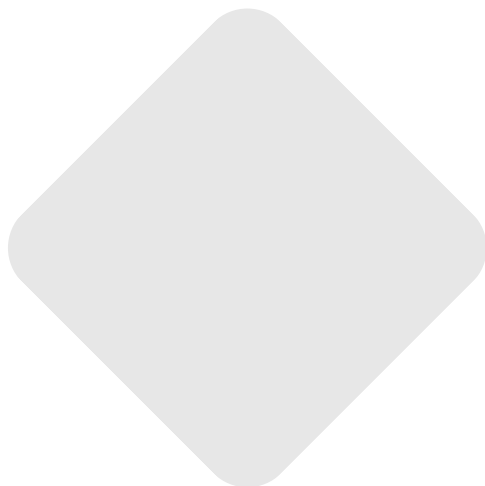

Carretera Nacional IV, Km 32
Apartado de correos 69
28350 Ciempozuelos
Madrid, España



alueuropa@alueuropa.com



+34 91 895 58 00