

**#RE**  
**LUX**  
**100%**

**#RE**  
**HYBRID**  
**90%**

**#RE**  
**80%**











# CLIMATIZACIÓN











*AIR CONDITIONING*











**CATÁLOGO**





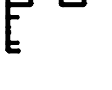

**2025**



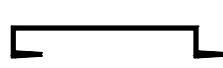

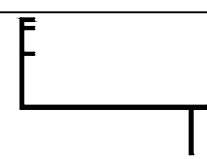
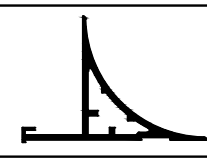
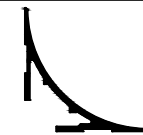

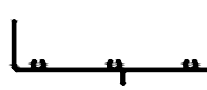











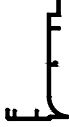

Referencia	Diseño	Descripción	Peso Kg/m	Perímetro mm	
				Total	Exterior
A-00019		lama aireación	0,089	38	-
A-00047		lama aireación	0,083	41	-
A-00324		lama aireación	0,093	43	-
A-05195		lama aireación	0,066	42,3	-
CI-088-0001		lama aireación	0,090	42,5	-
CI-051-0005		lama aireación	0,090	38	-
A-00544		lama aireación	0,105	50	-
A-00547		lama aireación	0,104	49	-
A-00927		lama aireación	0,090	39	-
A-00618		lama aireación	0,079	50	-

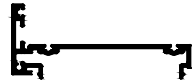







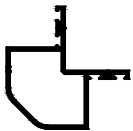

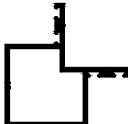
Referencia	Diseño	Descripción	Peso Kg/m	Perímetro mm	
				Total	Exterior
A-00620		lana curva aireación	0,103	62	-
A-00928		lana curva aireación	0,141	69	-
L-200336		lana curva aireación	0,152	63	-
A-00925		lana curva aireación	0,084	49	-
L-100744		lana curva aireación	0,106	54	-
A-02219		lana tubular ovalada aireación	0,216	131	73
A-05234		lana doble aireación	0,227	102	-
A-00656		lana tubular doble aireación	0,934	437	216
A-00020		solape soporte aireación	0,245	127	-
A-00087		solape soporte aireación	0,362	201	-









Referencia	Diseño	Descripción	Peso Kg/m	Perímetro mm	
				Total	Exterior
CI-051-0003		solape soporte aireación	0,246	128	-
CI-051-0004		solape soporte aireación	0,360	201	-
A-00322		solape soporte aireación	0,330	204,5	-
A-00323		solape soporte aireación	0,246	154,1	-
A-08498		solape soporte aireación	0,272	164,1	-
CI-088-0002		solape soporte aireación	0,256	154,5	-
CI-088-0003		solape soporte aireación	0,358	204,5	-
A-00021		remate bastidor aireación	0,629	258	-
A-00046		remate bastidor aireación	0,252	151	-
A-02208		remate bastidor aireación	0,230	135	-



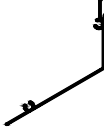

Referencia	Diseño	Descripción	Peso Kg/m	Perímetro mm	
				Total	Exterior
A-07546		remate bastidor aireación	0,271	158,7	-
A-07003		tapa soporte aireación	1,118	380,1	-
A-00195		tapa soporte aireación	0,276	148	-
CI-051-0002		tapa soporte aireación	0,274	148	-
A-07484		tapa soporte aireación	0,576	310,6	-
A-00030		bastidor aireación	1,004	359	250
A-00031		bastidor aireación	0,648	236	-
A-05235		tapa soporte aireación	0,262	126	-
A-00453		bastidor aireación	0,942	420	-
L-101032		bastidor aireación	1,183	420	-

Referencia	Diseño	Descripción	Peso Kg/m	Perímetro mm	
				Total	Exterior
A-00454		bastidor aireación	0,934	380	-
A-03735		tapa soporte aireación	0,958	358	-
A-03736		tapa soporte aireación	0,958	358	-
A-03737		tapa soporte aireación	0,673	251	-
A-03738		tapa soporte aireación	0,673	251	-
A-00617		soporte lama aireación	0,415	181	-
A-00619		soporte lama aireación	0,430	198	-
A-02217		soporte lama aireación	0,429	232	211
A-02218		soporte aireación	0,424	242	-
A-07191		soporte aireación	0,324	188,7	-

Referencia	Diseño	Descripción	Peso Kg/m	Perímetro mm	
				Total	Exterior
A-07548		bastidor aireación	0,722	348,4	-
A-00088		lama aireación	0,135	80	-
CI-051-0008		solape soporte aireación	0,118	81,5	-
A-07586		remate bastidor	0,141	92,2	-
CI-051-0007		solape soporte aireación	0,228	116,5	-
L-006459		solape soporte aireación	0,290	140	-
A-00451		tapa soporte aireación	0,138	88	-
A-00545		tapa soporte aireación	0,125	64	-
A-02216		acople soporte aireación	0,169	76	-
CI-046-004		soporte chaflan	1,004	399	263

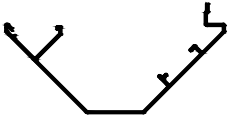
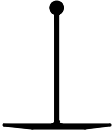
Referencia	Diseño	Descripción	Peso Kg/m	Perímetro mm	
				Total	Exterior
CI-046-005		soporte recto	1,054	419	273
CI-046-006		soporte 50 mm	0,919	308	192
A-00029		soporte en "T"	0,384	333	210
A-00622		remate bastidor aireación	0,214	130	-
A-05233		tapa soporte aireación	0,197	113	-
A-07545		lama aireación	0,129	80,8	-
A-07547		lama aireación	0,271	159,9	-
CI-164-0747		tapa soporte aireación	0,104	66,7	-
CI-164-0748		lama aireación	0,060	41,7	-
L-100626		lama aireación	0,211	85	-

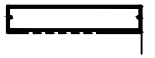
Referencia	Diseño	Descripción	Peso Kg/m	Perímetro mm	
				Total	Exterior
CI-051-0006		remate soporte aireación	0,167	91	-
L-100628		tapa soporte aireación	0,225	99	-
L-100161		tapa soporte aireación	0,240	139	-
A-05915		bastidor aireación	0,394	134	-
A-07002		bastidor aireación	0,700	206,5	-
CI-164-0749		bastidor aireación	0,251	152,8	-
CI-164-0750		bastidor aireación	0,258	147,3	105,4
A-07360		lama aireación	0,313	220,8	-
A-00022		lama aireación	0,130	70	-
CI-051-0001		lama aireación	0,131	70	-

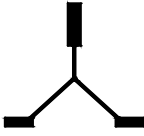
Referencia	Diseño	Descripción	Peso Kg/m	Perímetro mm	
				Total	Exterior
A-00926		lama aireación	0,204	107	-
L-100639		soporte aireación	1,380	598	-
A-03734		soporte bastidor	2,036	440	-
L-503156		bastidor aireación	1,183	747	457
L-503952		bastidor aireación	0,943	415	219
L-503462		bastidor aireación	2,587	920	467
L-503958		bastidor aireación	2,646	944	487
I-09037		lama estrella aireación	1,442	331,4	-

A-00019

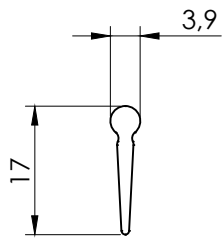

A-00047

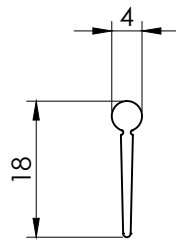

A-00324

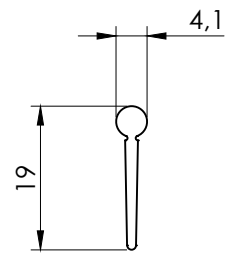

A-05195

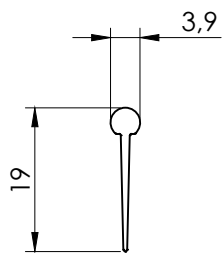

CI-088-0001

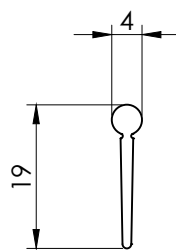

CI-051-0005

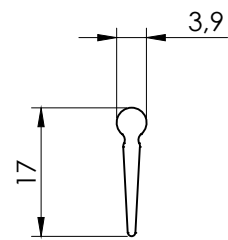

A-00544

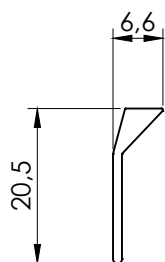

A-00547

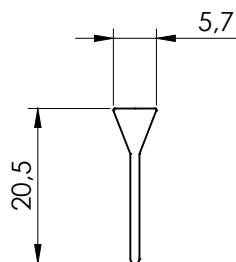

A-00927

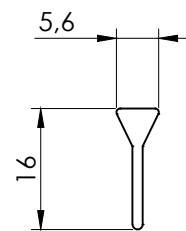

A-00618

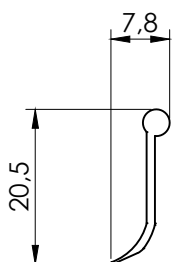

A-00620

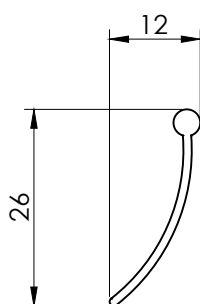

A-00928

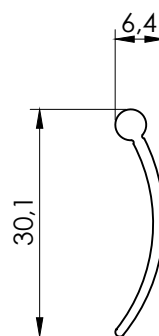

L-200336

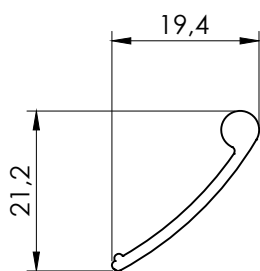

A-00925

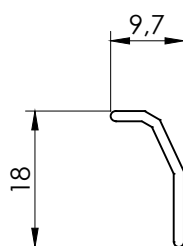

L-100744

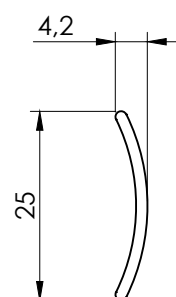

A-02219

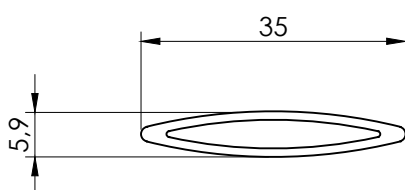

A-05234

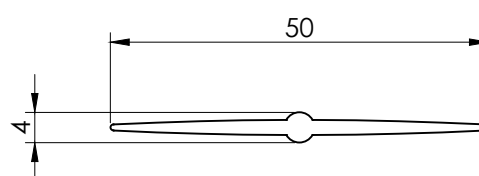

A-00656

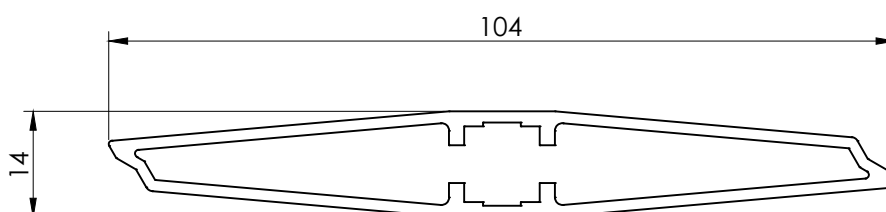

A-00020

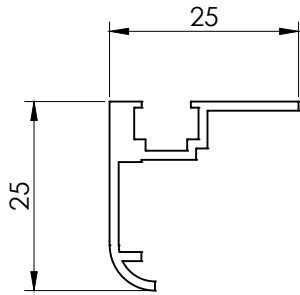

A-00087

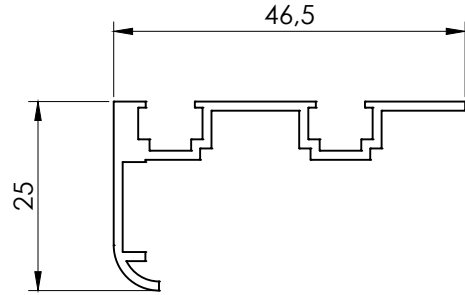

CI-051-0003

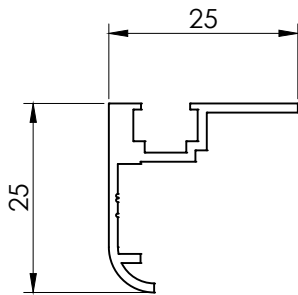

CI-051-0004

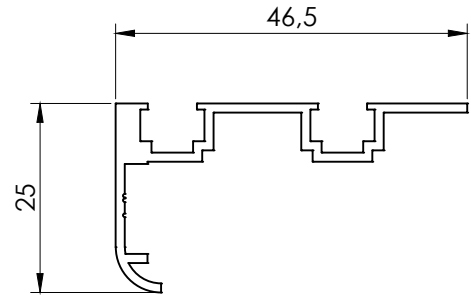

A-00322

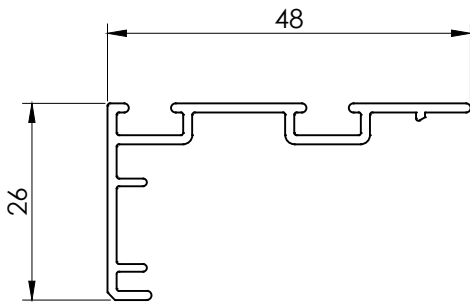

A-00323

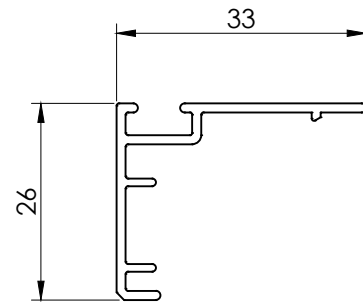

A-08498

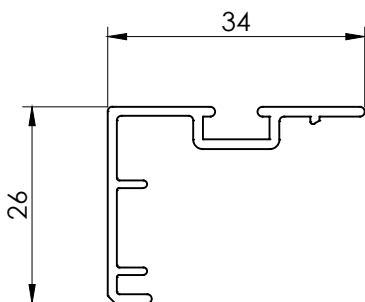

CI-088-0002

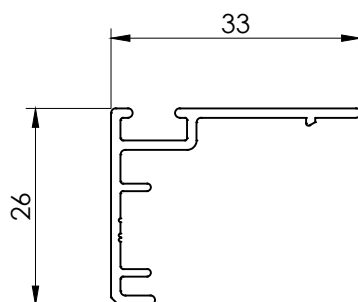

CI-088-0003

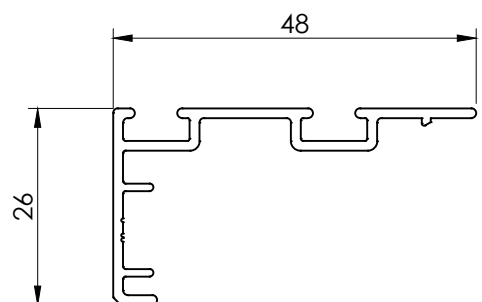

A-00021

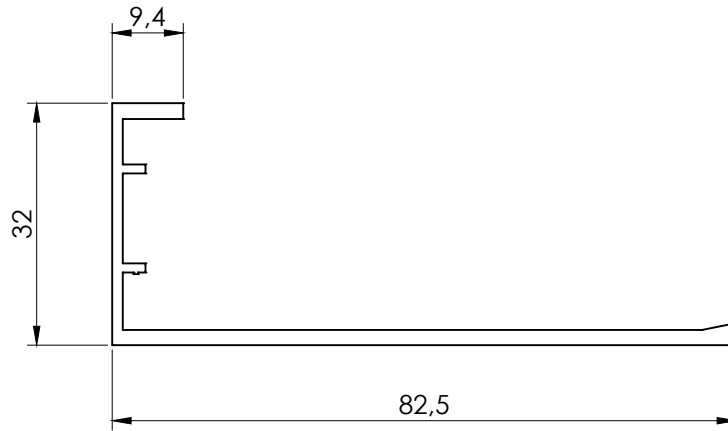

A-00046

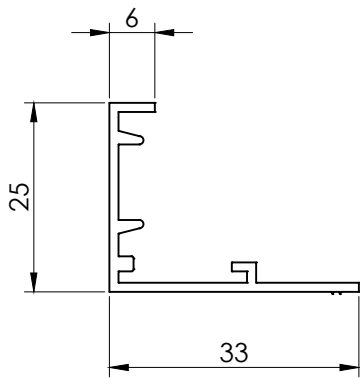

A-02208

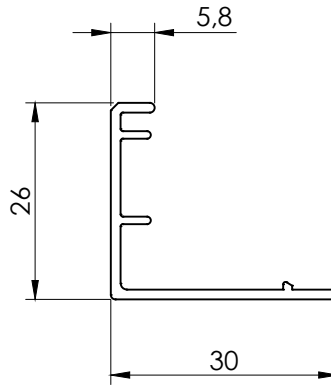

A-07546

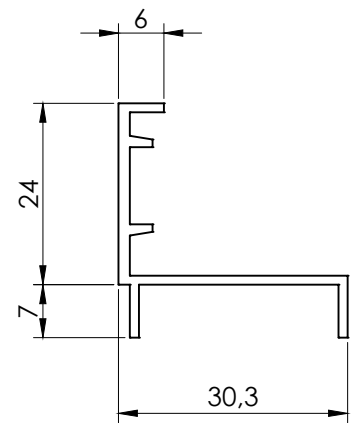

A-07003

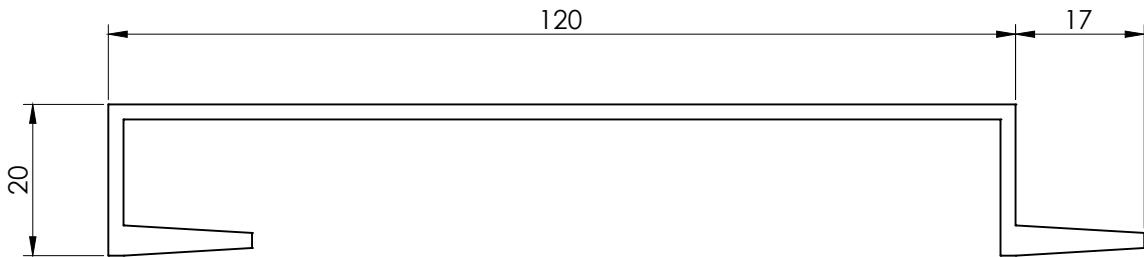

A-00195

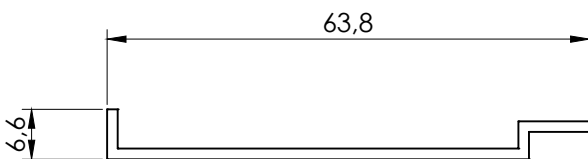

CI-051-0002

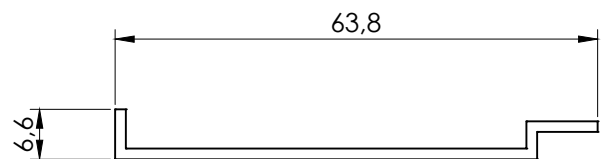

A-07484

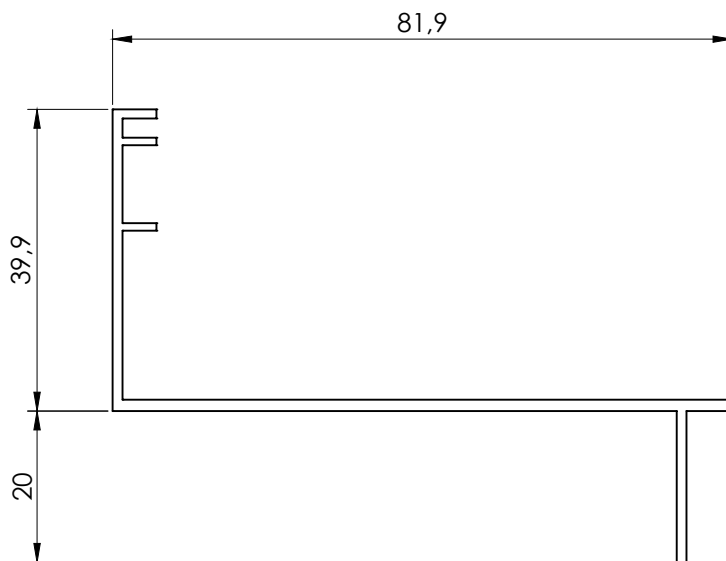

A-00030

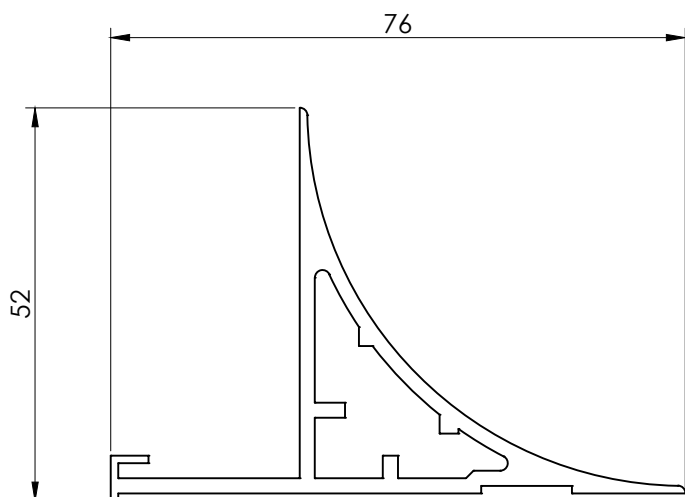

A-00031

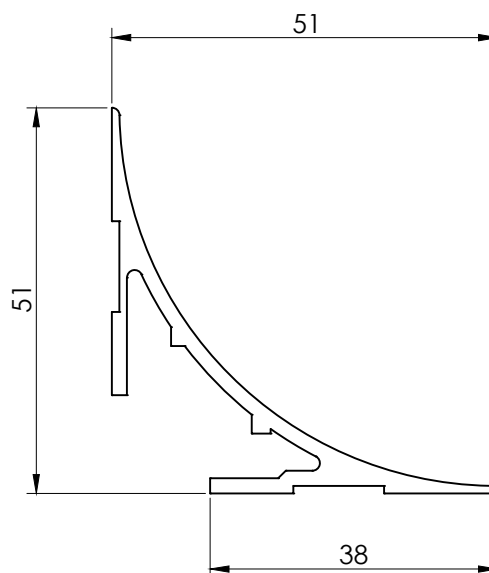

A-05235

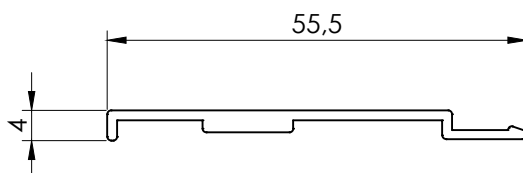

A-00453

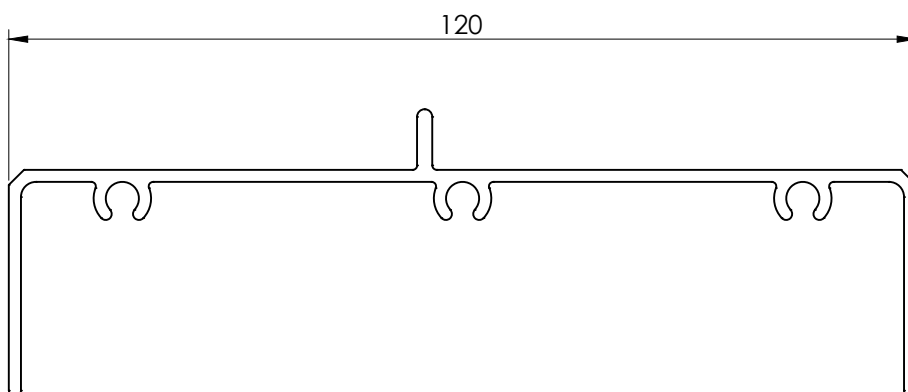

L-101032

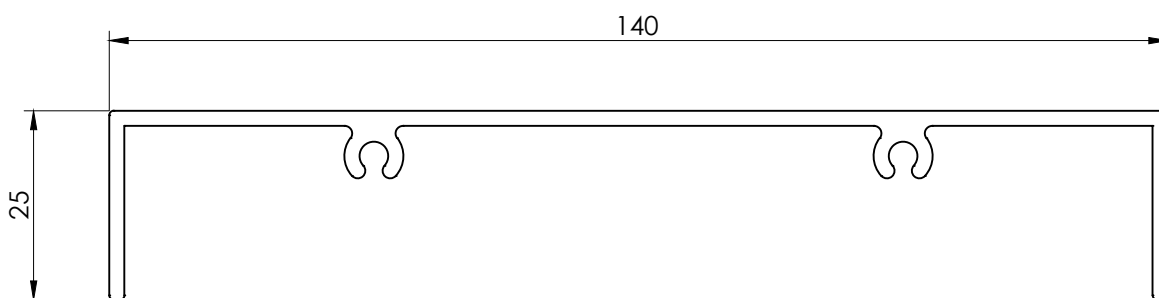

A-00454

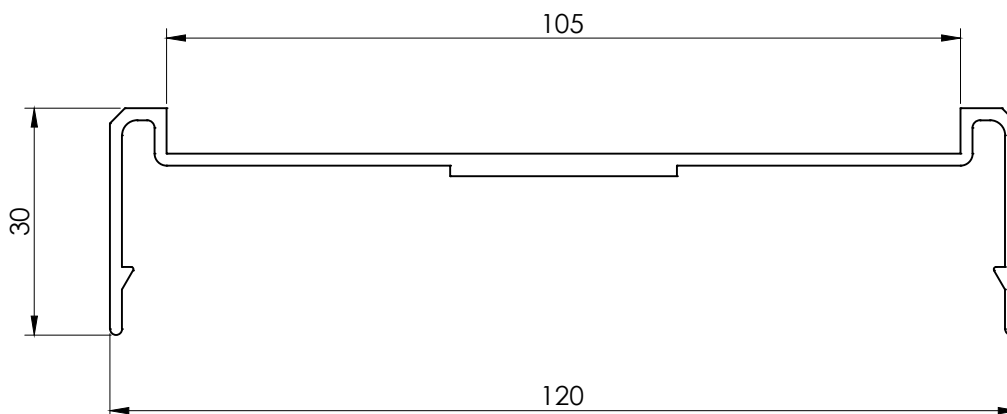

A-03735

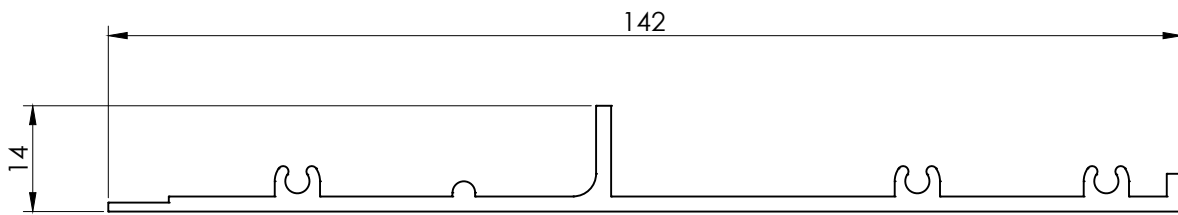

A-03736

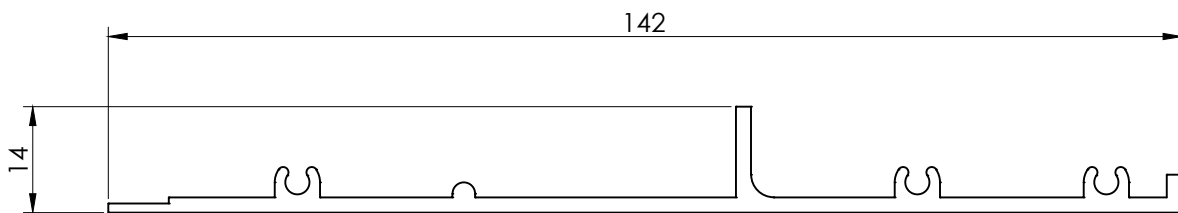

A-03737

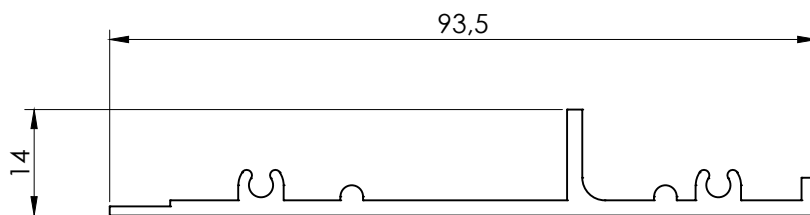

A-03738

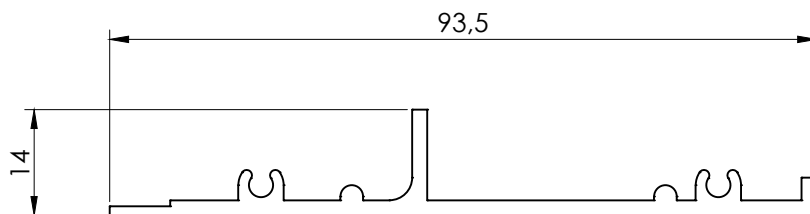

A-00617

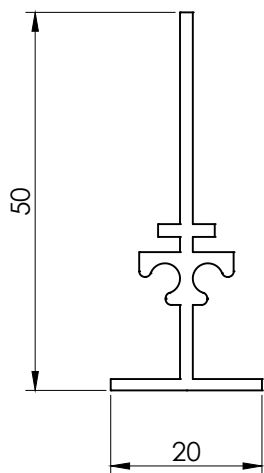

A-00619

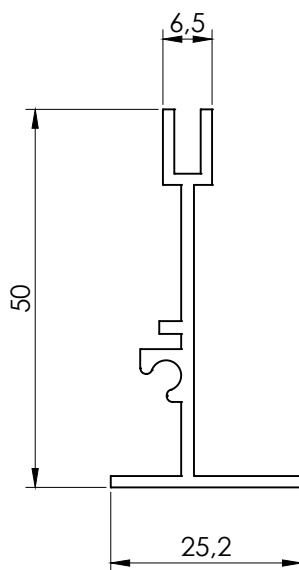

A-02217

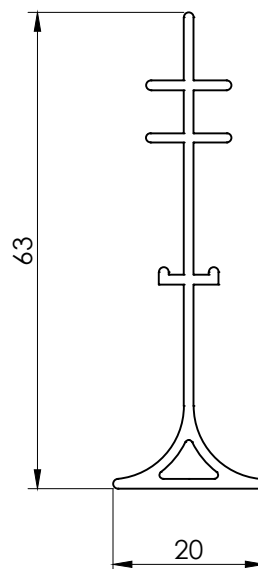

A-02218

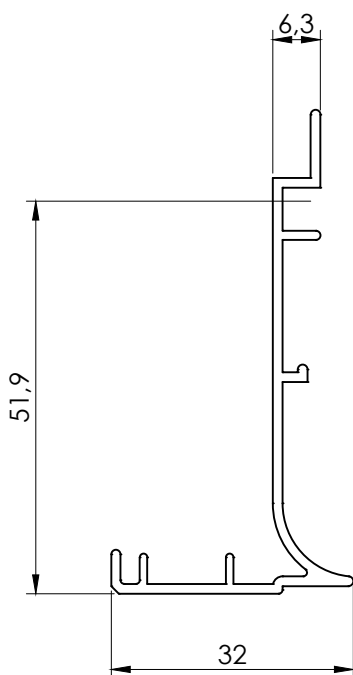

A-07191

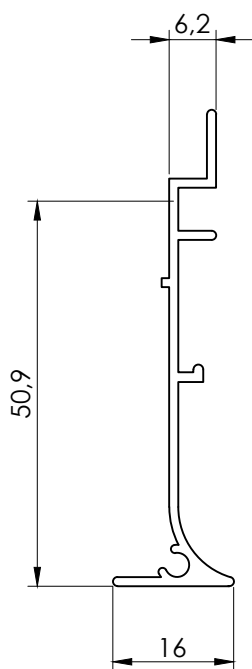

A-07548

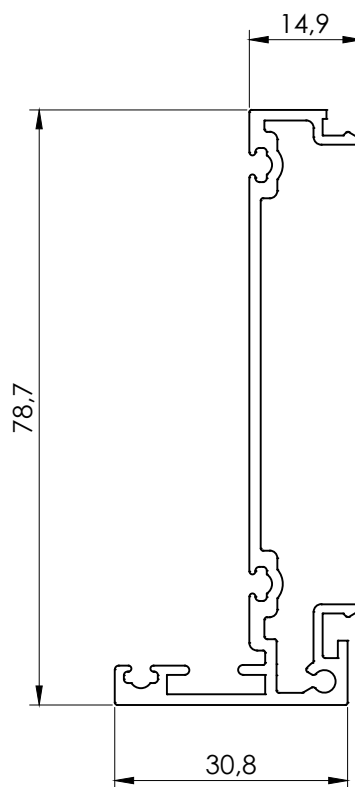

A-00088

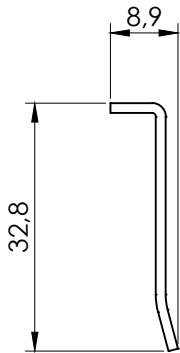

CI-051-0008

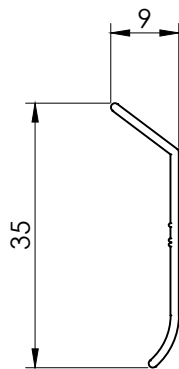

A-07486

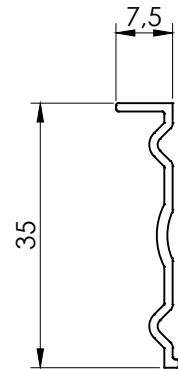

CI-051-0007

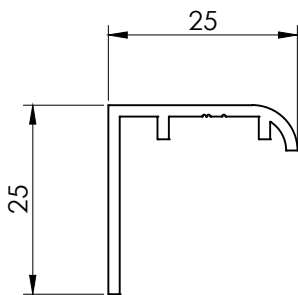

L-006459

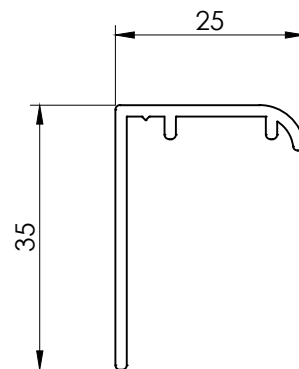

A-00451

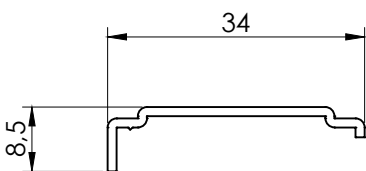

A-00545

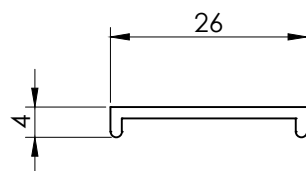

A-02216

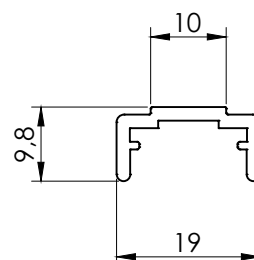

CI-046-004

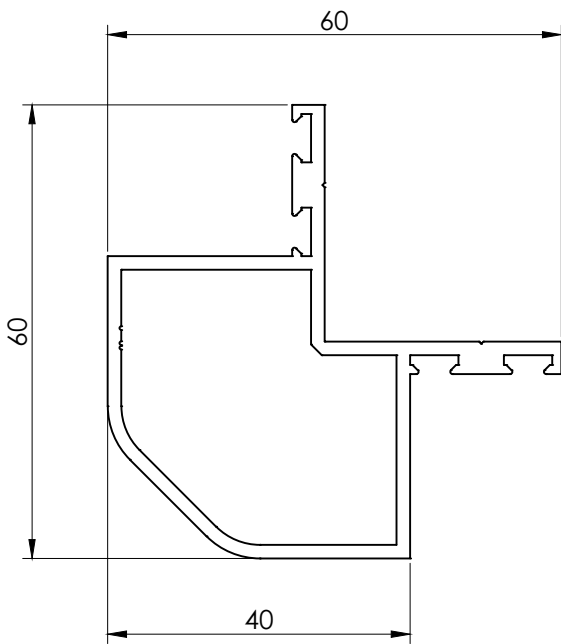

CI-046-0005

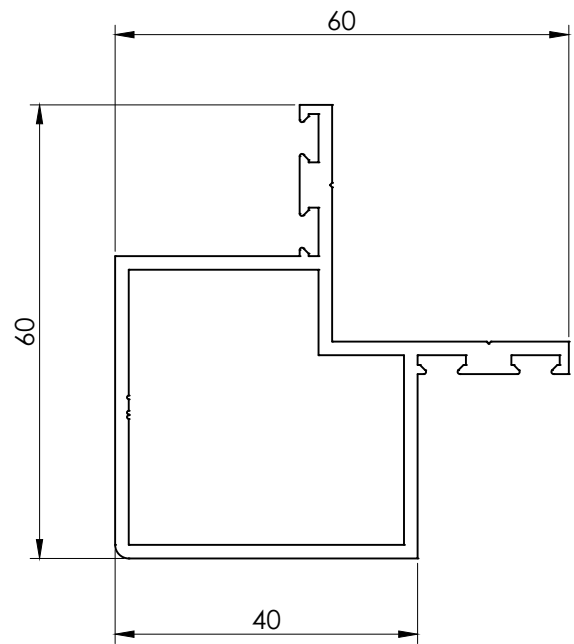

CI-046-0006

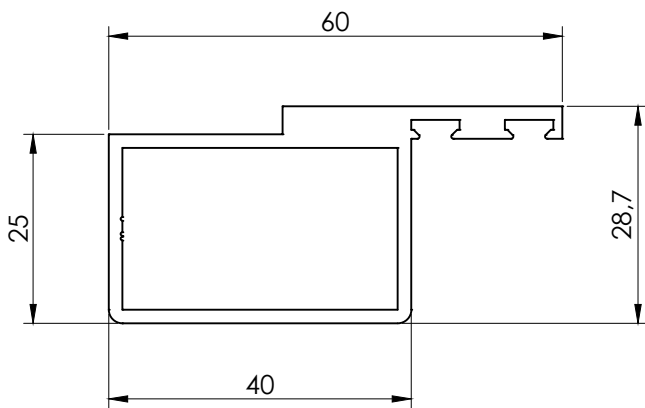

A-00029

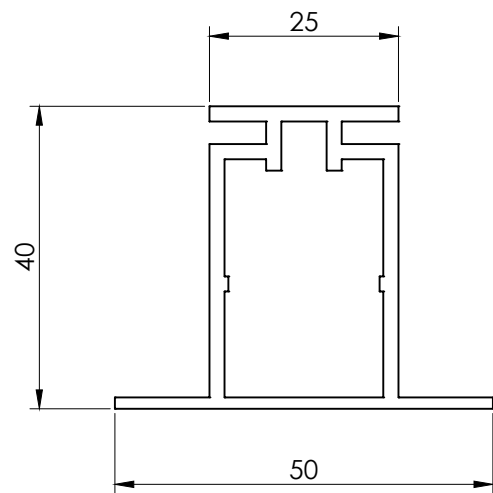

A-00622

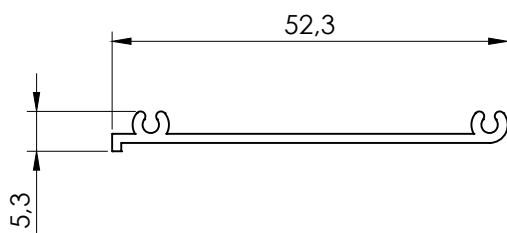

A-05233

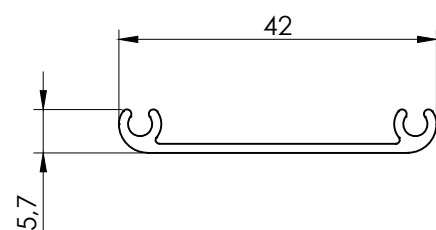

A-07545

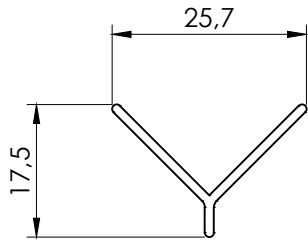

A-07547

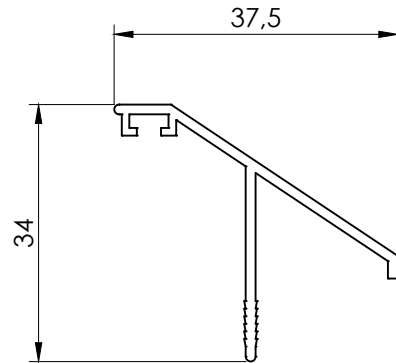

CI-164-0747

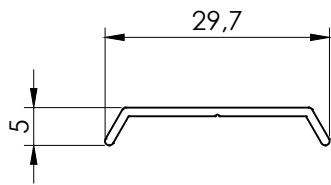

CI-164-0748

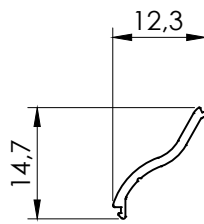

L-100626

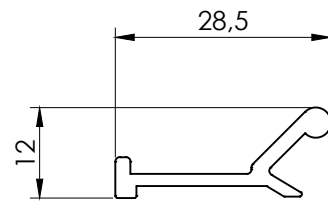

CI-051-0006

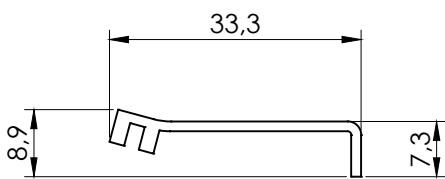

L-100628

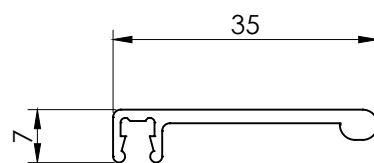

L-100161

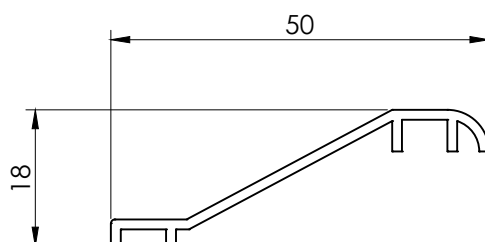

A-05915

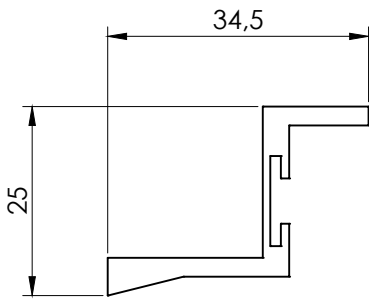

A-07002

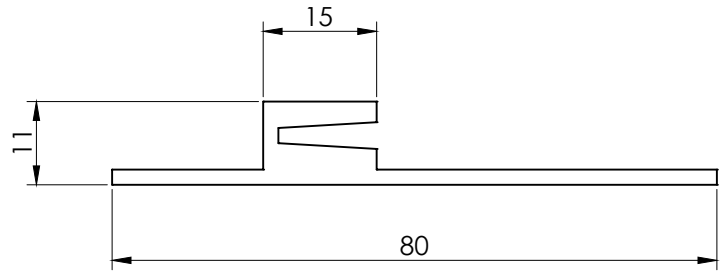

CI-164-0749

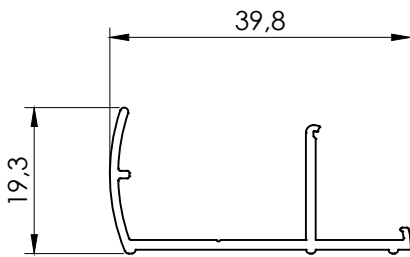

CI-164-0750

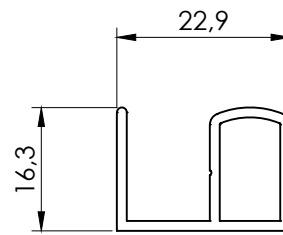

A-07360

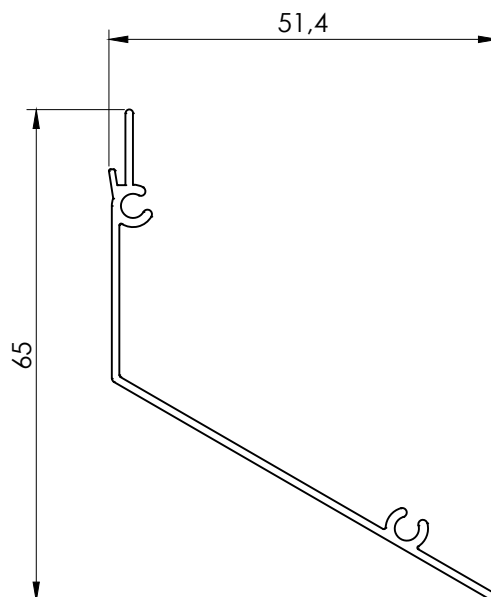

A-00022

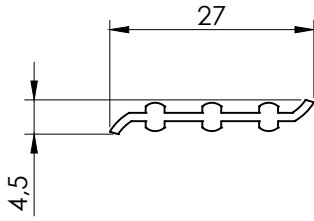

CI-051-0001

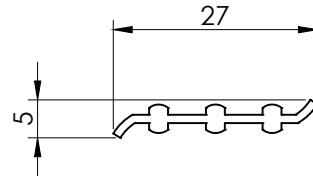

A-00926

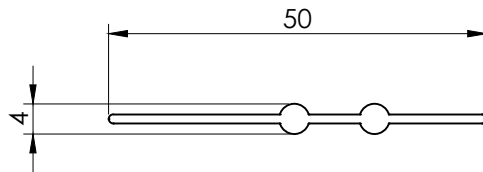

L-100639

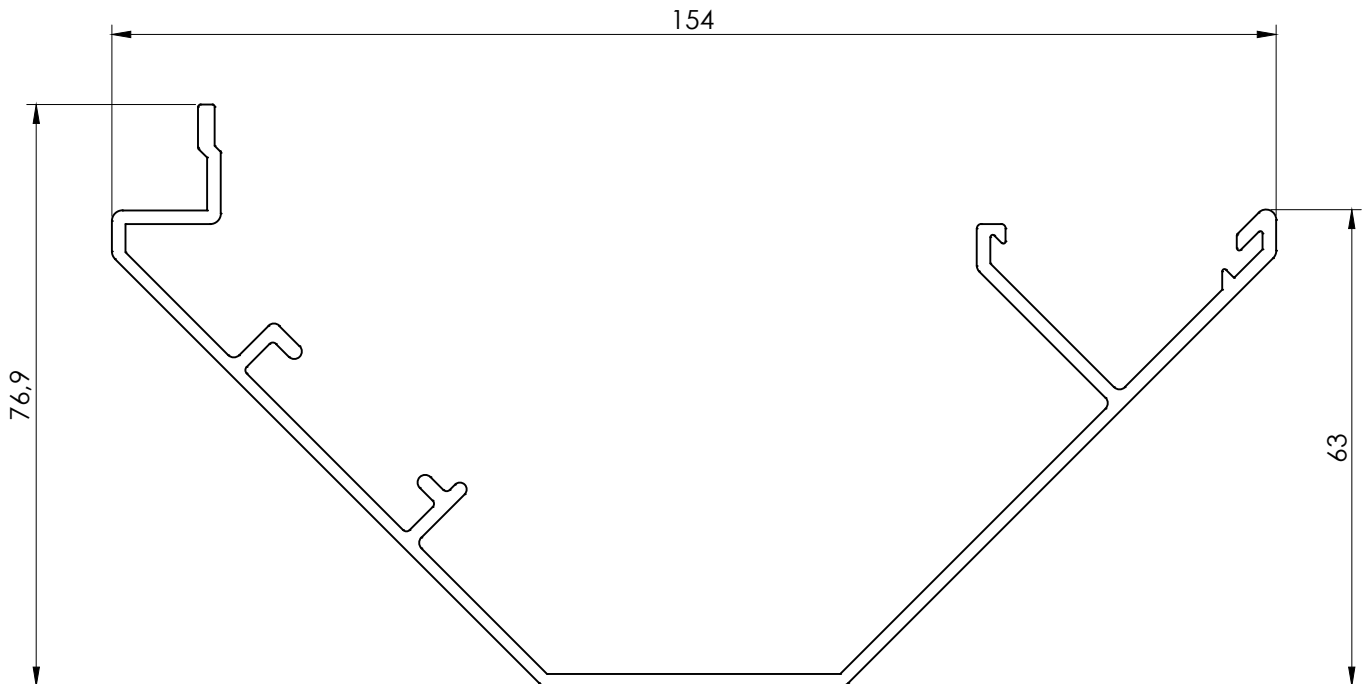

A-03734

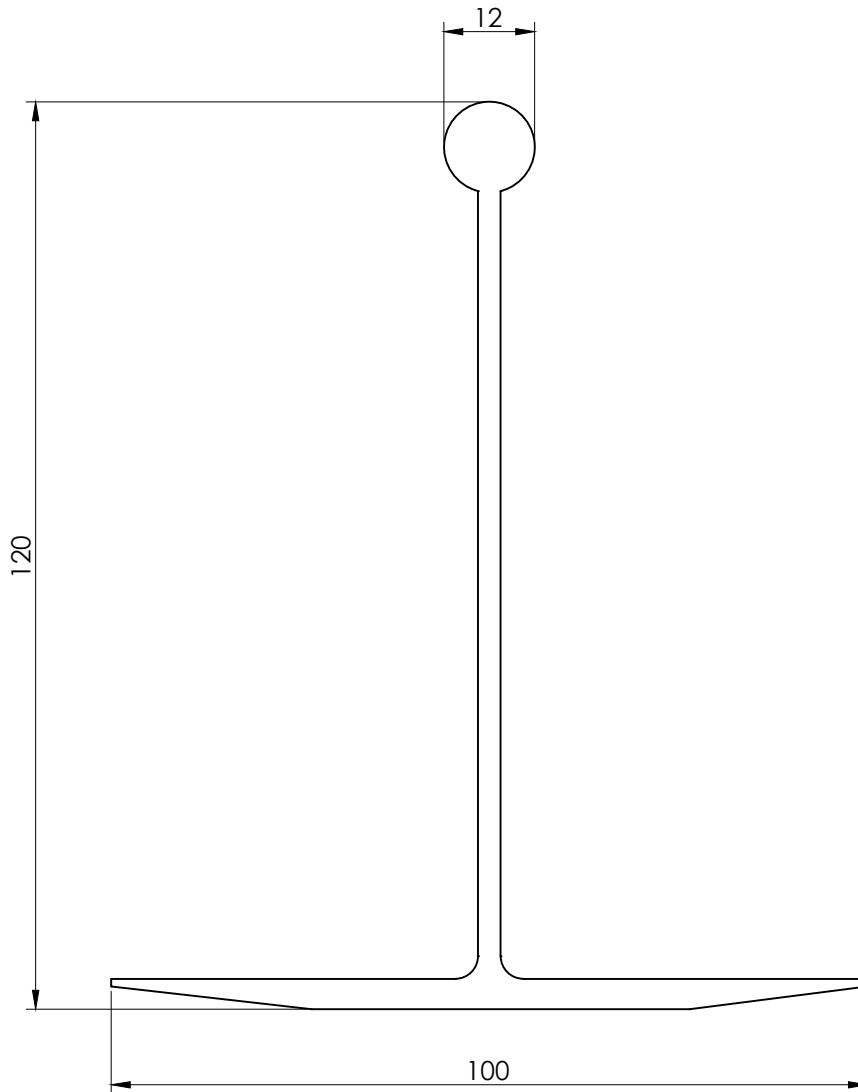

L-503156

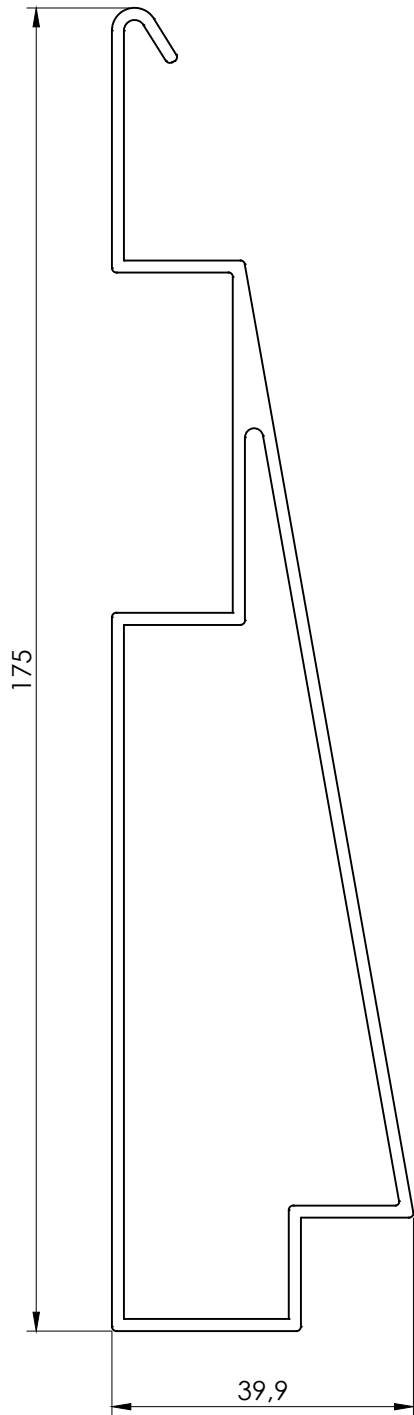

L-503952

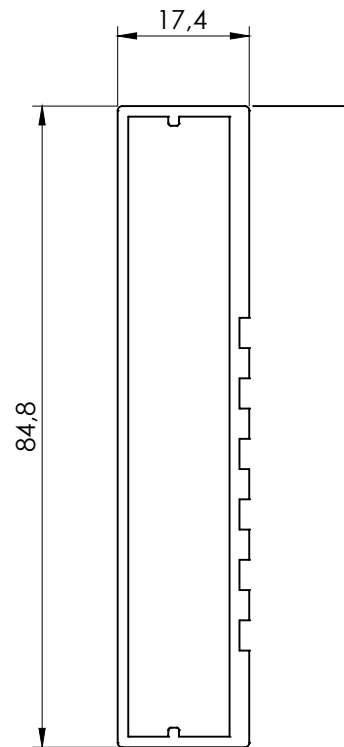

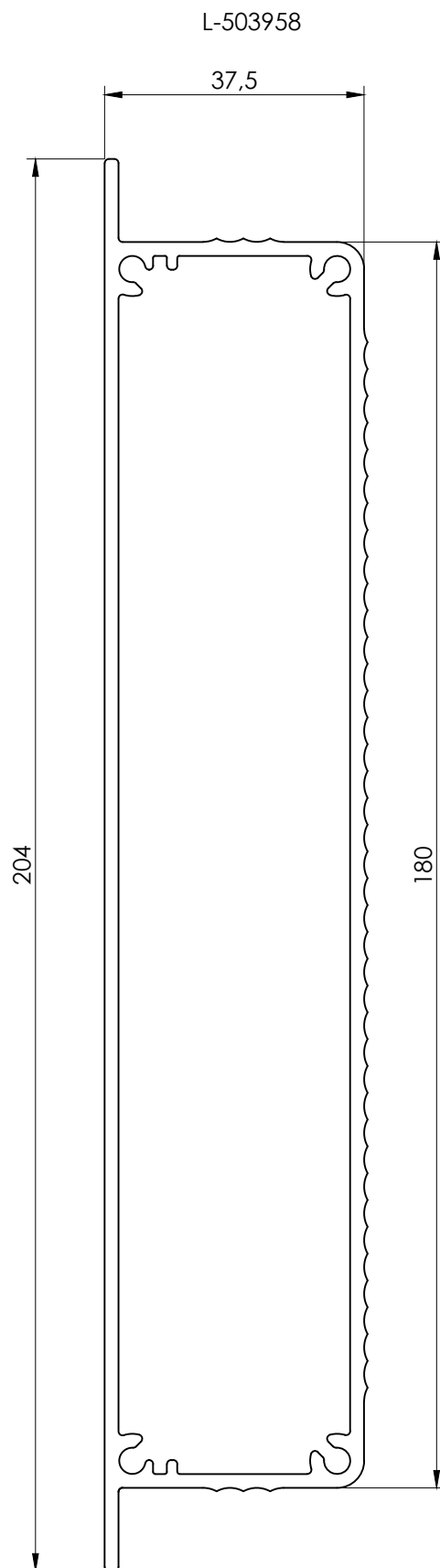
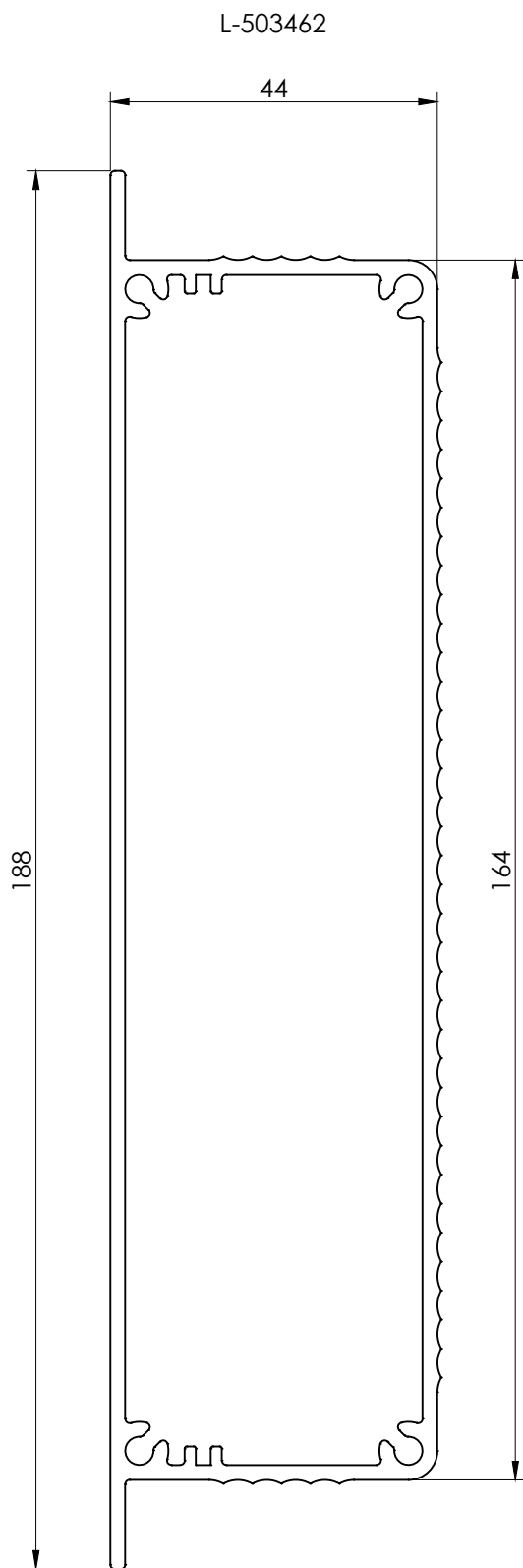

I-09037

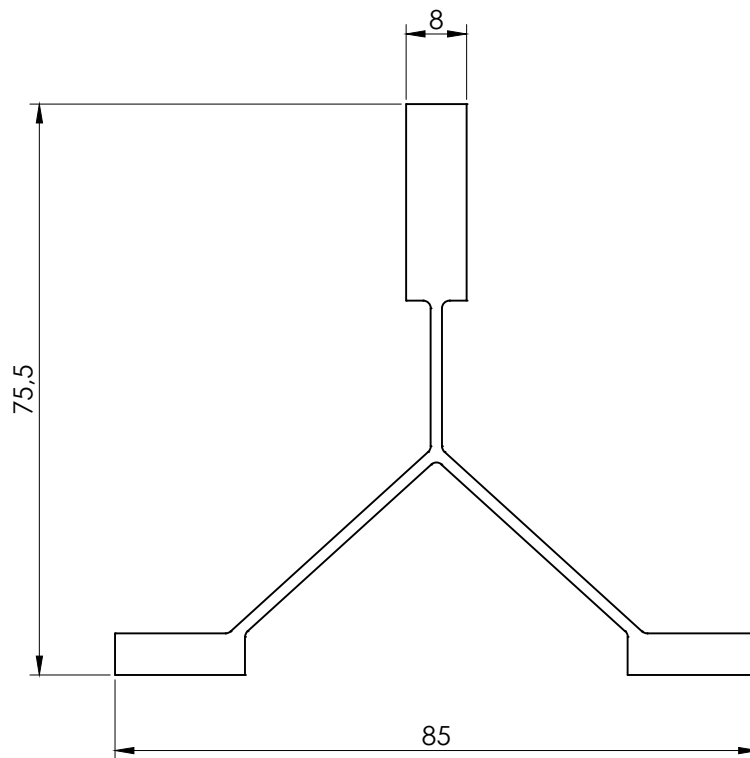

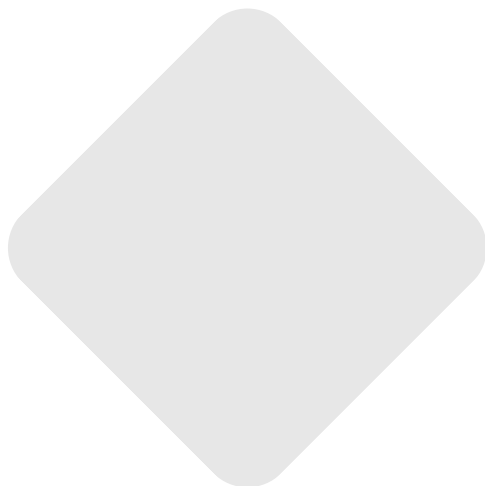

Carretera Nacional IV, Km 32  
Apartado de correos 69  
28350 Ciempozuelos  
Madrid, España



[alueuropa@alueuropa.com](mailto:alueuropa@alueuropa.com)



+34 91 895 58 00