

**#RE**  
**LUX**  
**100%**

**#RE**  
**HYBRID**  
**90%**

**#RE**  
**80%**

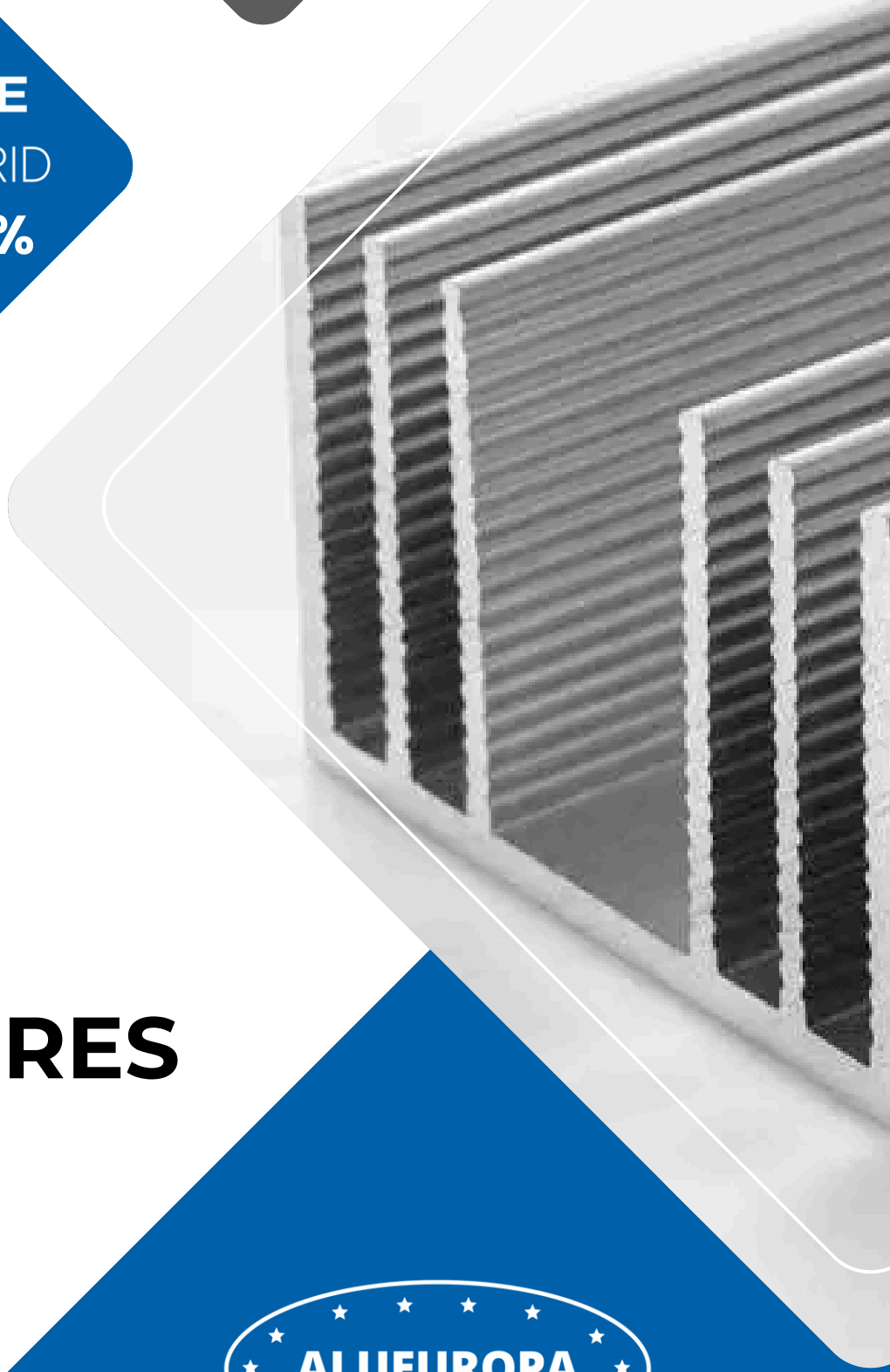











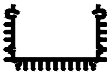

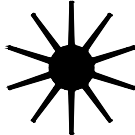

# DISIPADORES

*HEATSINK*

**CATÁLOGO**  
**2025**



Referencia	Diseño	Descripción	Peso Kg/m	Perímetro mm	
				Total	Exterior
A-06695		disipador calor	9,833	1734	-
A-07096		disipador calor	2,348	496,1	-
A-10575		disipador calor	2,386	879	-
A-13447		disipador calor	1,164	520	-
CI-027-0022		disipador calor	1,652	421,5	-
CI-164-0602		disipador calor 115 mm	3,735	1410,5	-
L-006924		disipador calor	0,125	71	-
L-100934		disipador calor	1,596	383	-
L-100948		disipador calor	3,116	502	-
L-100949		disipador calor	7,012	906	-

Referencia	Diseño	Descripción	Peso Kg/m	Perímetro mm	
				Total	Exterior
L-200426		disipador calor	0,778	398	-
L-300039		disipador calor	3,907	981	-
L-503331		disipador calor	4,104	1218	890
I-05200		disipador calor	16,073	1673	-
I-05071		disipador calor 250 mm	7,348	1803,7	-
I-05203		disipador calor 255 mm	41,286	2438,3	-

A-06695

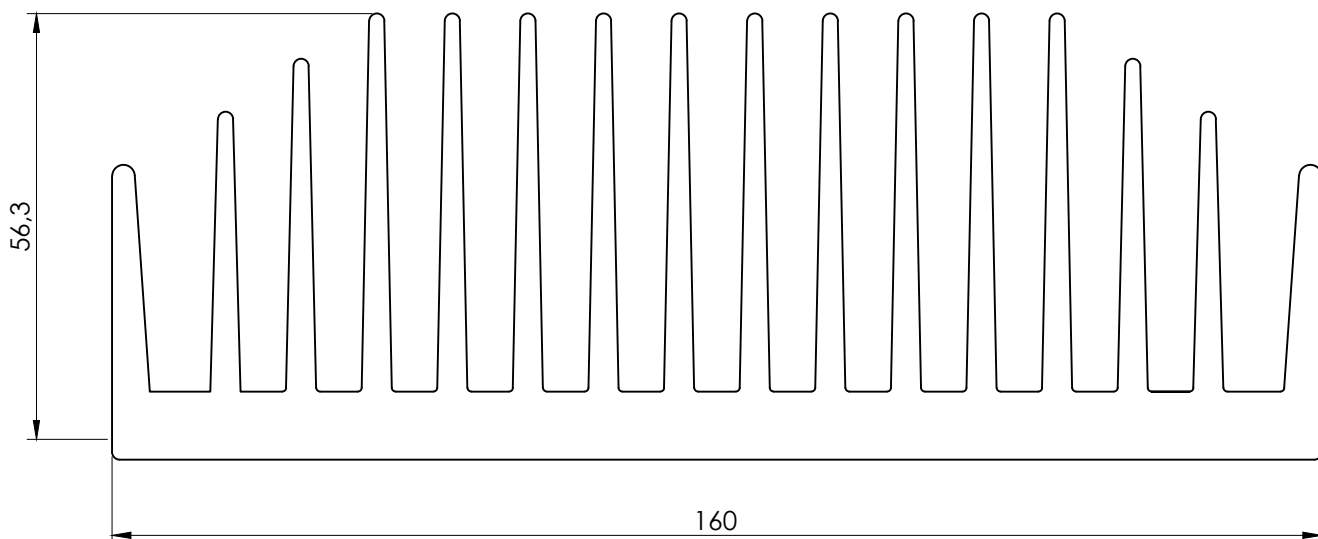

A-07096

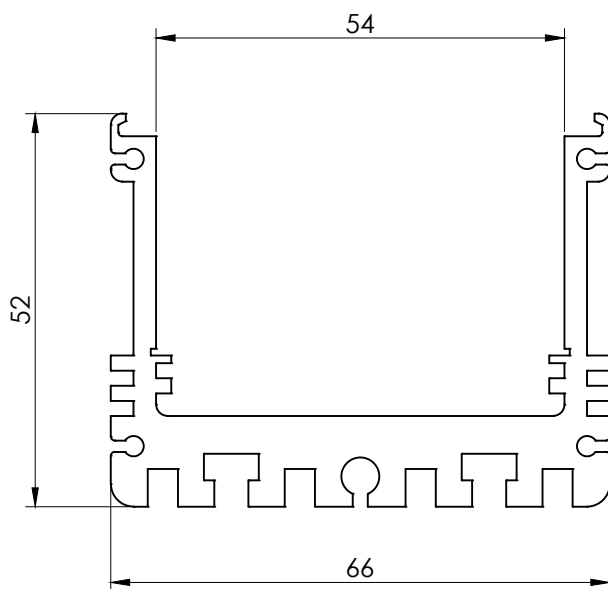

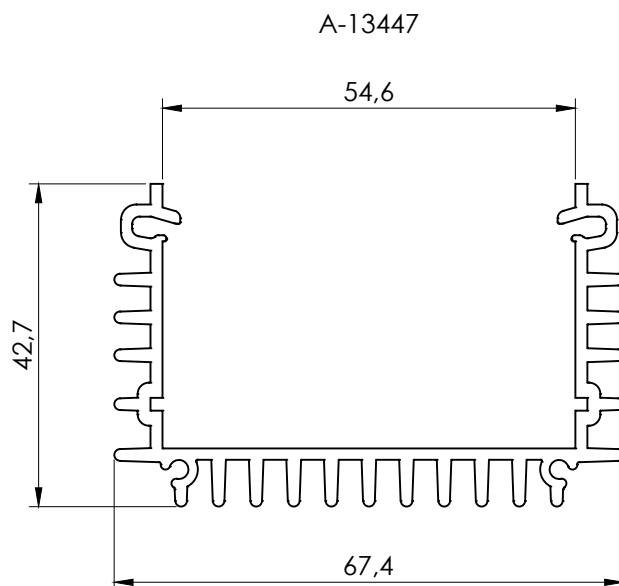
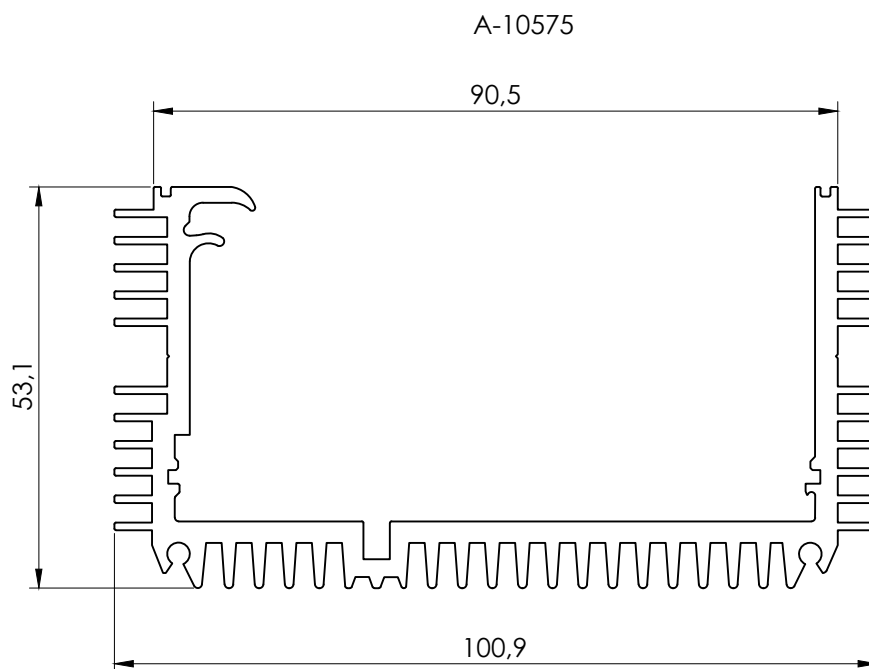

CI-027-0022

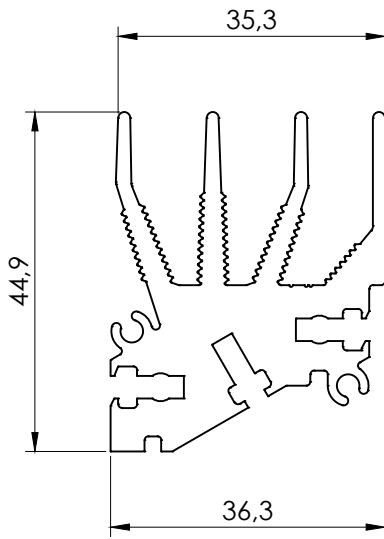

L-006924

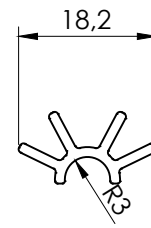

CI-164-0602

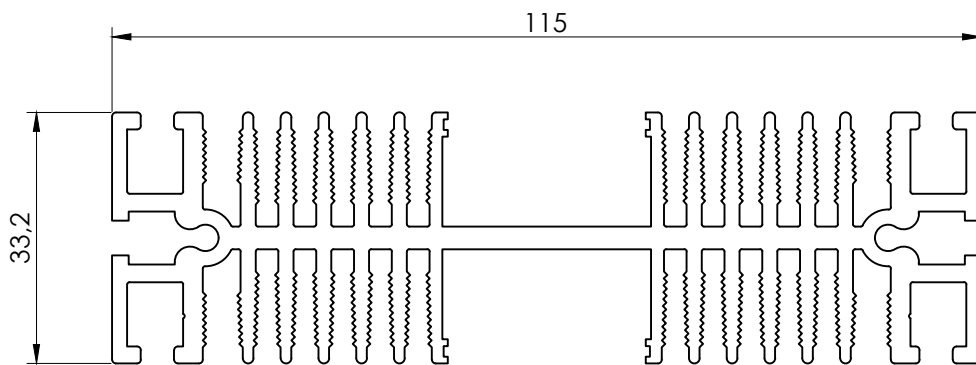

L-100934

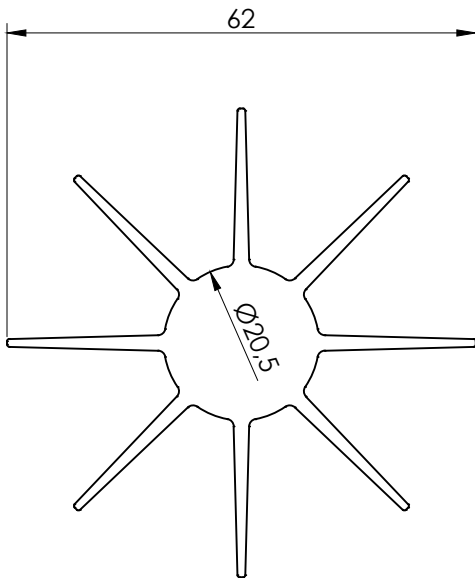

L-100948

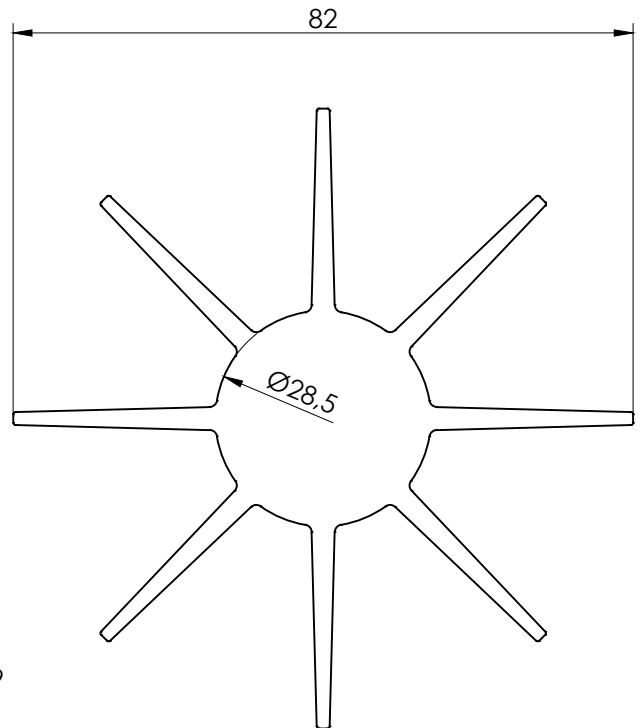

L-100949

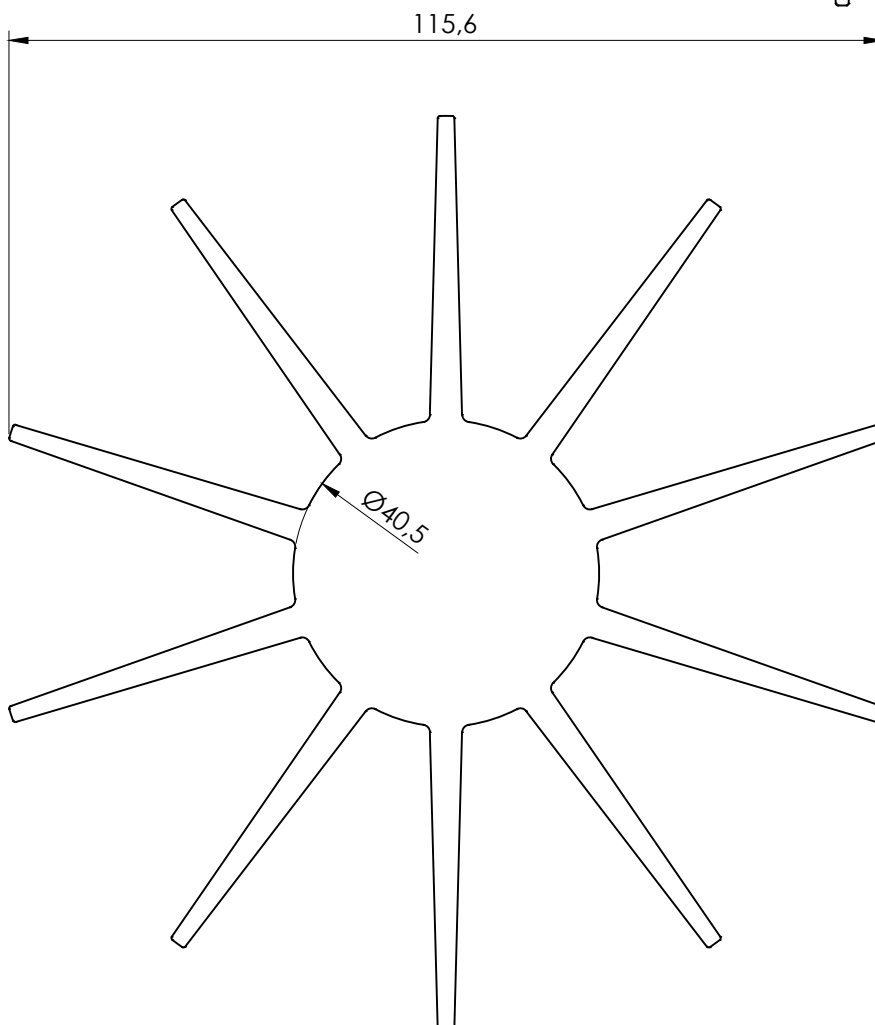

L-200426

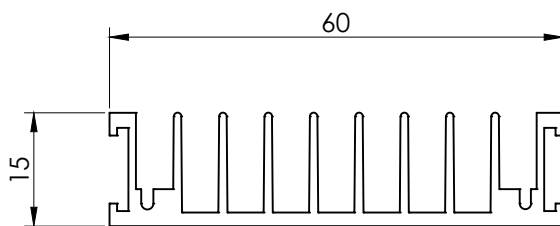

L-300039

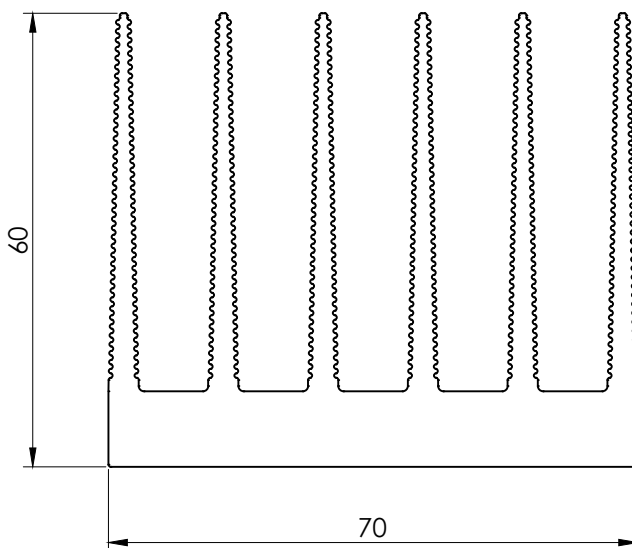

L-503331

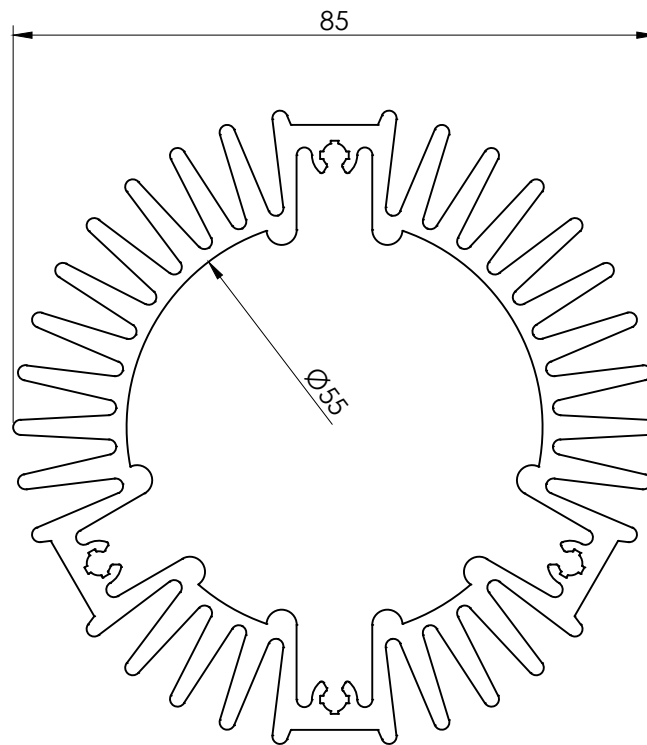

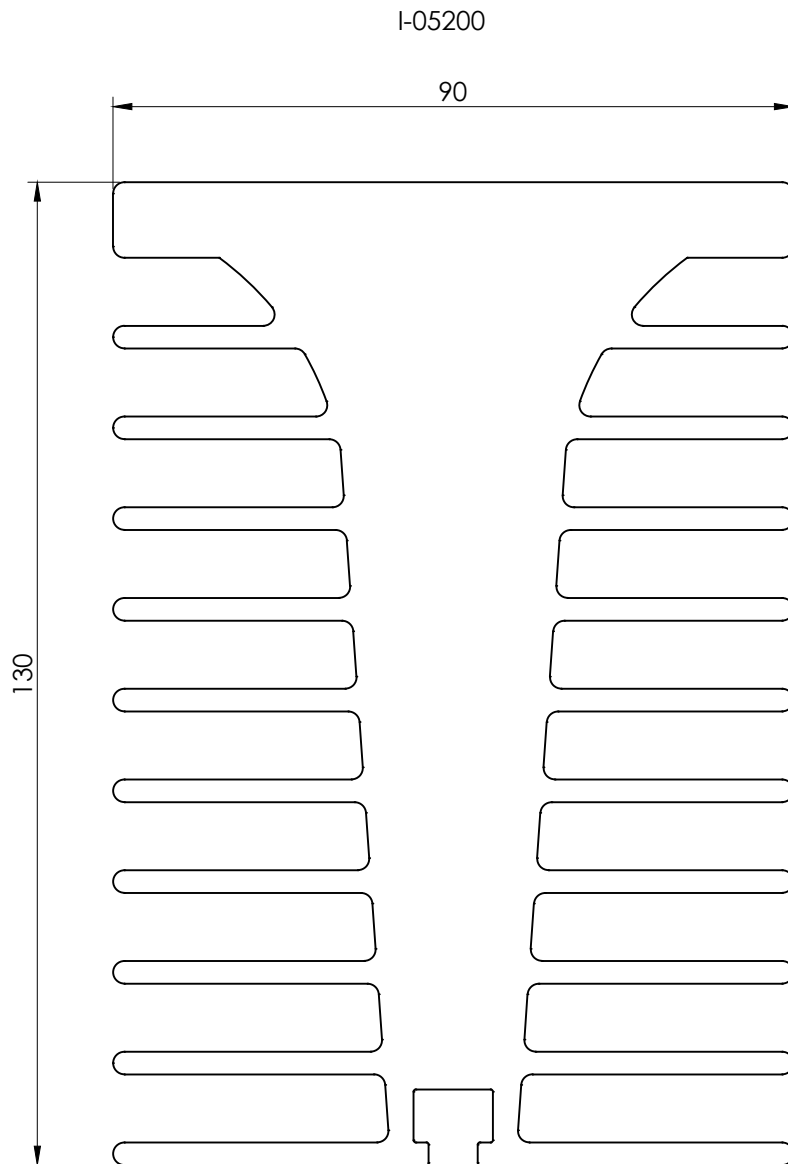

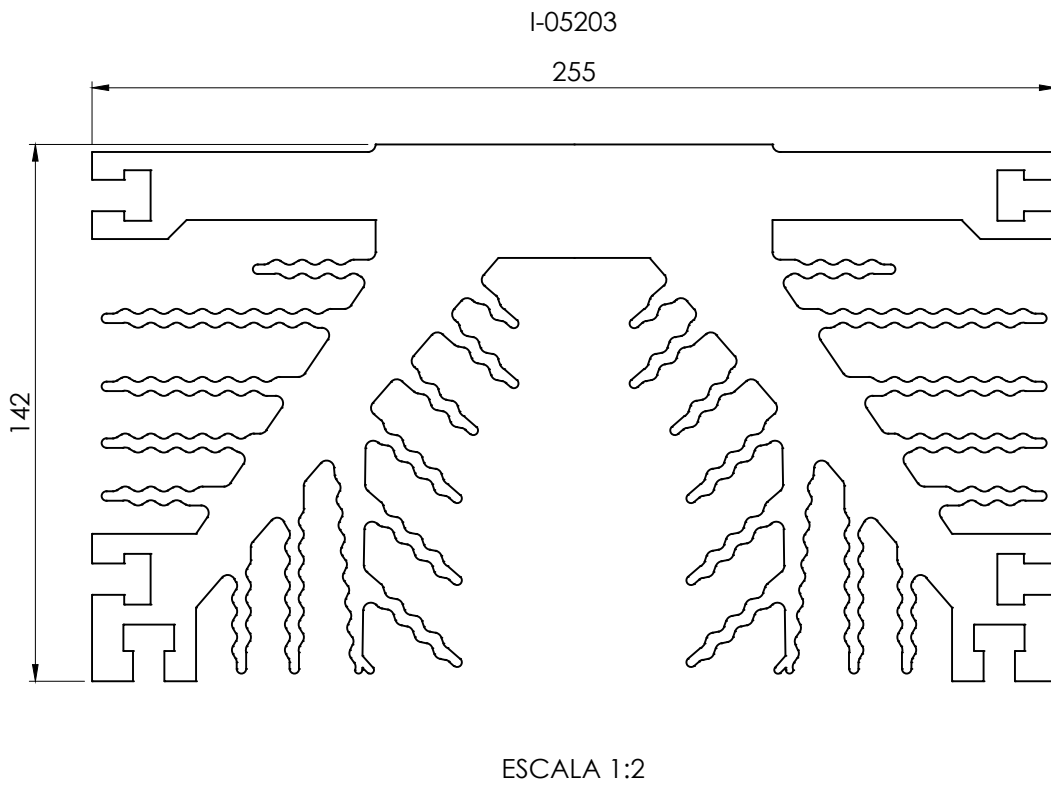
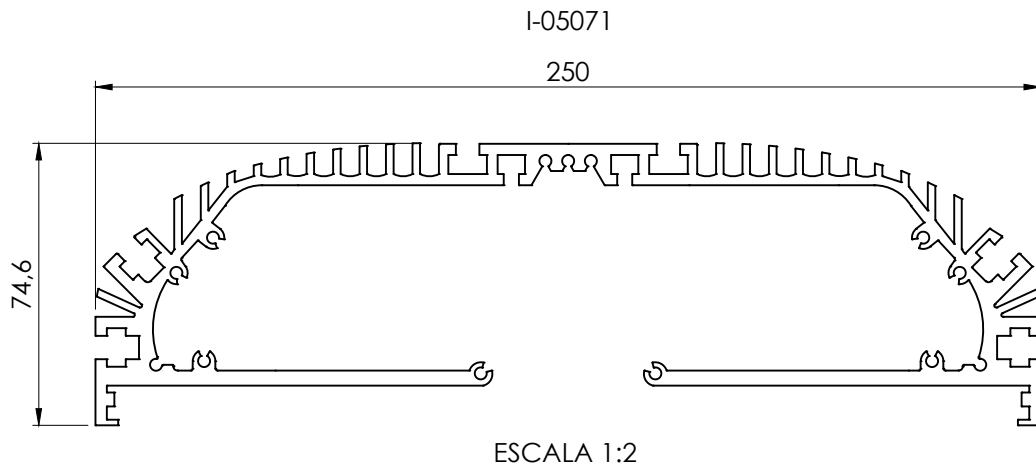

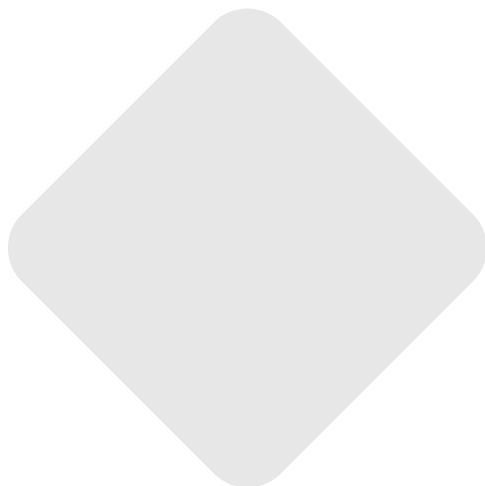

Carretera Nacional IV, Km 32  
Apartado de correos 69  
28350 Ciempozuelos  
Madrid, España



[alueuropa@alueuropa.com](mailto:alueuropa@alueuropa.com)



+34 91 895 58 00